

## Process and Temperature Controllers – Codix 850 / 851



### Your benefit

- multifunctional, i.e. all usual measuring signals can be connected directly (voltage, current, thermocouples, resistance thermometers, resistance)
- flexible limit value monitoring (2 limit values)
- HART® communication socket for setting parameters
- LCD display and keys for on-site operation for model 851
- programmable input characteristic curve with up to 32 control points

### More advantages

- programmable via PC or keys
- integrated measuring transducer power supply
- RS232 interface for parameter setting and measured values output
- analog output with scale factor for current or voltage of the linearised input

### Technical data

Supply voltage:	18 ... 36 V DC	Weight:	approx. 280 g [9.877 oz]
(galvanically isolated)	20 ... 28 V AC, 50/60 Hz	Interface:	RS 232, 3.5 mm [0.138"] stereo socket on housing front side
	90 ... 253 V AC, 50/60 Hz	Connection:	coded, plug-in screw terminal, max. wire gauge 1.5 mm <sup>2</sup> [0.062"]
Power consumption:	max. 4 VA	Inputs:	0 ... 1 V, 0 ... 20 V, ±100 mV, ±10 V 0 ... 20 mA, 4 ... 20 mA, ±20 mA Pt100, Ni100, potentiometers, thermocouples T, J, K, N, R, S, B, L, U, W3, W5
Display:	5-digit LCD-Display; height 6 mm [0.236"], LED's to indicate limit values, operation and fault conditions	Measuring speed	1 measurement/second
Fuses:	AC: 315 mA slow blow; DC: 1 A slow blow	Accuracy:	0.05 % FSD
Data backup:	EEPROM	Internal resistance:	voltage : 1 MΩ ; current: 5 Ω
Housing:	plastic PC/ABS, UL94 V0	Outputs:	0 ... 20 mA, 4 ... 20 mA, 20 ... 4 mA, 20 ... 0 mA 0 ... 10 V, fault behaviour acc. to NAMUR NE43
Ambient temperature:	-10 ... +50 °C [14 °F ... 122 °F]	Resolution:	D/A: current 13 bits, voltage 15 bits
Storage temperature:	-30 ... +70 °C [-22 °F ... 158 °F]	Limit value contacts:	optional 2 relays, each with 1 change-over contact 250 V AC/30 V DC, 5 A
EMC:	Immunity to interference: EN55011 class B Emitted interference EN61000-6-2		
Protection:	IP 20		

### Dimensions:

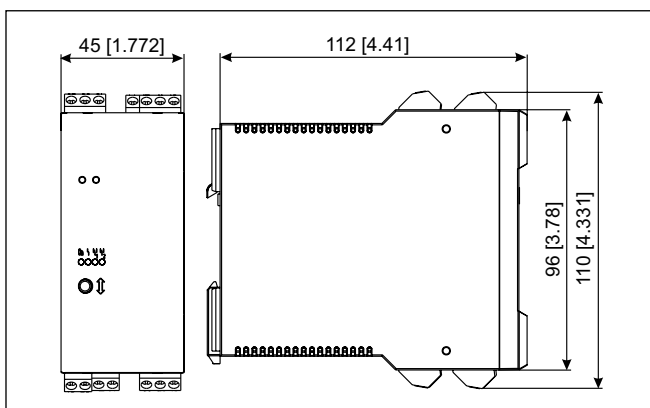

### Applications:

- Appliances
- Electrical cabinets and laboratory equipment
- Temperature display/monitoring
- Process acquisition/monitoring
- Process control
- Signal matching/conversion

### Example: Linearisation of the characteristic curve of a container

Our process controllers linearise the relationship between the fill-up level  $h$  and the volume  $V$  of the container. This can be set exactly thanks to 24 or 32 control points. The devices 850/851 can output the linearised values as current or as voltage values (e.g. 4 ... 20 mA) and thus offer in addition the function of a voltage transformer.

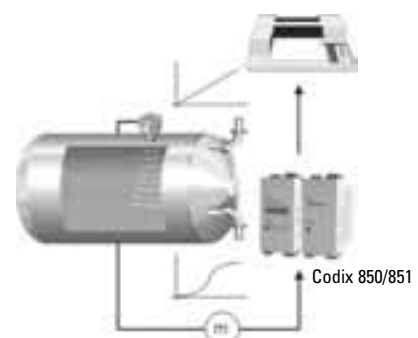

## Process and Temperature Controllers – Codix 850 / 851

### Connections

#### Supply voltage and outputs

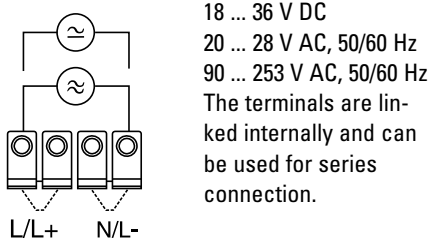

#### Measuring transducer (internal circuit)

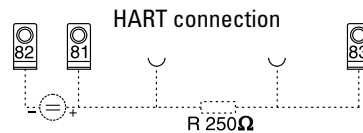

#### Measuring transducer excitation 2-wire sensor

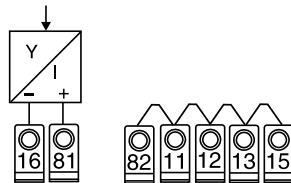

#### Relays (internal circuit)

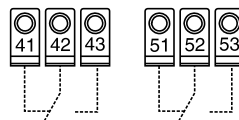

#### Relays (internal circuit)

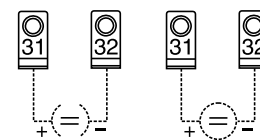

#### Current input ±20 mA, 0/4 ... 20 mA

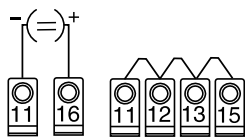

#### Voltage input ±100 mV, thermocouples

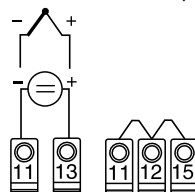

#### Voltage input ±10 V, 0 ... 1/10 V

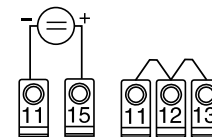

#### Resistance thermometers/potentiometers 2-wire

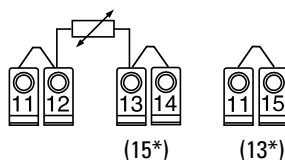

#### 3-wire

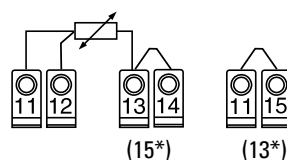

#### 4-wire

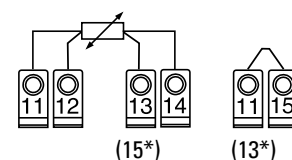

Connect Pt 500 and Pt 1000 to terminal 15, link 13 and 11

#### Order information:

Series	0 = Codix 850 (without display) 1 = Codix 851 (5-digit LCD, 3 keys)*
Limit values	0 = 2 relays* 2 = no limit values

0.85X.00X.XXX

Interface	05 = RS232 serial interface 95 = analogue output and RS232 serial interface *
Supply voltage	0 = 90 ... 253 V AC* D = 18 ... 36 V DC and 20 ... 28 V AC

Please note:  
The combination 0.850.002.X05 is not available.

#### Advice:

The use of the PC-Software with RS 232 connection cable (to be ordered separately) is strictly required for all versions 0.850.XXX.XXX. It is also recommended when using the 0.851.XXX.XXX versions to facilitate the device set up.

#### Order information:

N. 150.060 PC-Software including RS 232 connection cable