

Safe-System	LES02 / PSU02	Safety functions according to EN 81-20/21/50
--------------------	----------------------	---



The PSU02 evaluation unit is used in combination with the Ants LES02 sensor to implement elevator and safety functions in accordance with EN 81-20/-21/-50.

The absolute car position is determined 100 % slip-free via the SIL3-certified Ants LES02 sensor. The PSU02 evaluates this safe position data and activates the required safety functions together with the elevator controller via safety relays.



Features and benefits

- Digitization of elevator systems**
 Safe determination, transmission and processing of position and speed information of the elevator car.
- Safety circuit**
 The PSU02 evaluation unit is a central component in the safety concept of every elevator system. It communicates with the elevator control system and opens the safety circuit via safety relays depending on the application or in the event of a fault.
- Smart Teaching – simple and safe**
 In order to be able to digitally simulate the traditional shaft installation, we offer a Smart Teaching Unit with which, for example, the position of the emergency limit switches or the door zone information can be taught into the PSU02 via smartphone.
- Elimination of existing components**
 Numerous components such as magnetic switches, ramps, roller limit switches can be eliminated thanks to the digitally available shaft information.
- Minimization of installation and maintenance times**
 Reduced installation and maintenance times due to fewer components with their integration into the overall system. Even the mounting kit for the installation of code band and sensor is designed according to the „plug-and-play“ principle.

Required components for the use of the LES02 / PSU02 safe system

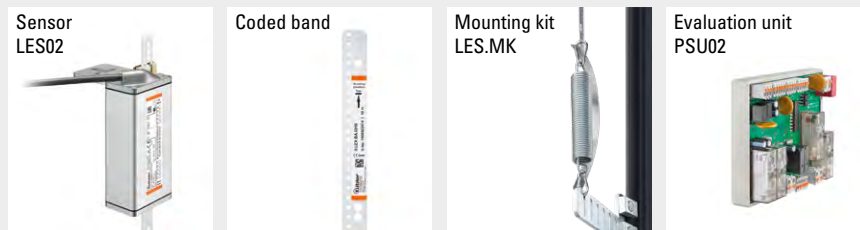

Shaft copying systems

Safe-System	LES02 / PSU02	Safety functions according to EN 81-20/21/50
--------------------	----------------------	---

Kübler Safe-System



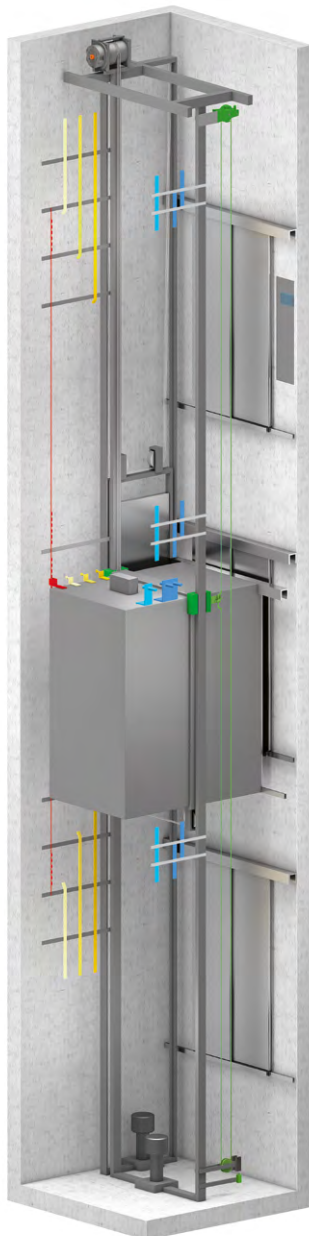

Conventional elevator system

Modern elevator system with Kübler Safe system LES02 / PSU02
Safety functions without triggering of safety gear

Modern elevator system with Kübler Safe system LES03 / SGT02 / PSU02
Safety functions with triggering of safety gear



Shaft copying systems

Safe-System	LES02 / PSU02	Safety functions according to EN 81-20/21/50				
Kübler Safe-System						
Realizable elevator and Safety functions	Standard references	SIL	 LES02 PSU02	 LES03 SGT02	 LES03 SGT02 PSU02	 LES03 PSU03
				Safe System LES03/SGT02	Safe System LES03/SGT02/PSU02	in development LES03/PSU03
Absolute position feedback	no standard reference	–	✓	✓	✓	✓
Final limit switch	EN 81-20: 5.12.2.3.1 b)	1	✓	–	✓	✓
Retardation control (in case of reduced stroke buffers)	EN 81-20: 5.12.1.3	3	✓	–	✓	✓
UCM (Unintended Car Movement)	EN 81-20: 5.6.7.7	2	✓	–	✓	✓
Door bridging	EN 81-20: 5.12.1.4 a), b), c), 2), d)	2	✓	–	✓	✓
Two redundant signals for the door zone (door zone magnet emulation)	no standard reference	–	✓	–	✓	✓
Door zone signalization in case of evacuation with 12 V emergency power supply	no standard reference	–	–	–	✓	✓
Overspeed pretripping 115 %	EN 81-20: 5.6.2.2.1.6	2	(✓) functional	✓	✓	✓
Triggering electromech. safety gear in case overspeed	EN 81-20: 5.6.2.2.1	3	–	✓	✓	✓
Status control of electromechanical safety gear	EN 81-20: 5.6.2.1.5	1	–	✓	✓	✓
Reset control of electromech. safety gear	no standard reference	3	–	✓	✓	✓
Triggering electromechanical safety gear in case of upwards movement	EN 81-20: 5.6.6.5	2	–	✓	✓	✓
Triggering electromechanical safety gear in case of activating emergency braking switch	no standard reference	3	–	✓	✓	✓
Inspection limit switch within reduced shaft head / pit	EN 81-21: 5.5.3.4, 5.7.3.4	2	✓	✓	✓	✓
Shield Mode: triggering of electromechanical safety gear for ensuring refuge space	EN 81-21: 5.5.2.3, 5.7.2.3	2	–	✓	✓	✓
Triggering switch for opening safety circuit (within reduced shaft head / pit)	EN 81-21: 5.5.2.3.3 f)	2	–	✓	✓	✓
Reset device control	EN 81-21: 5.5.3.3 c)	2	–	✓	✓	✓
Shield Mode: refuge space during scaffoldless installation	no standard reference	3	–	✓	✓	✓
Functional safety already from wiring (without presetting)	no standard reference	3	✓	–	✓	✓
Overspeed during inspection (0.63 m/s)	EN 81-20: 5.12.1.5.1 e)	–	✓	✓	✓	✓
Safe configuration management for accelerated approval process	no standard reference	–	–	✓	✓	✓

Shaft copying systems

Safe-System	LES02 / PSU02	Safety functions according to EN 81-20/21/50
--------------------	----------------------	---

Technology in detail

Conventional elevator system – mechanical components

In conventional elevator systems, detecting the position of the elevator car and the resulting triggering of safety functions involves a great deal of effort. Numerous mechanical components from magnetic flags to limit switches and ramps are used for this purpose. This leads to high installation, maintenance and cost efforts. In the event of a malfunction, troubleshooting can be correspondingly time-consuming.

In this design, the high safety requirements for elevator systems are mainly met by redundant components. With the entry into force of EN 81-20/21/50, the safety requirements for passenger and freight elevators have increased even further. The design of conventional elevator systems is therefore becoming even more complex.



Mechanical overspeed governor



Inspection switch



Emergency limit switch



Delay control



Door zone monitoring



Flush door position

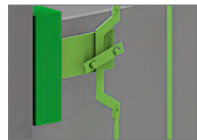

Mechanical trigger of the safety gear



Tensioning device for overspeed governor



Switch for slack rope monitoring (governor rope)

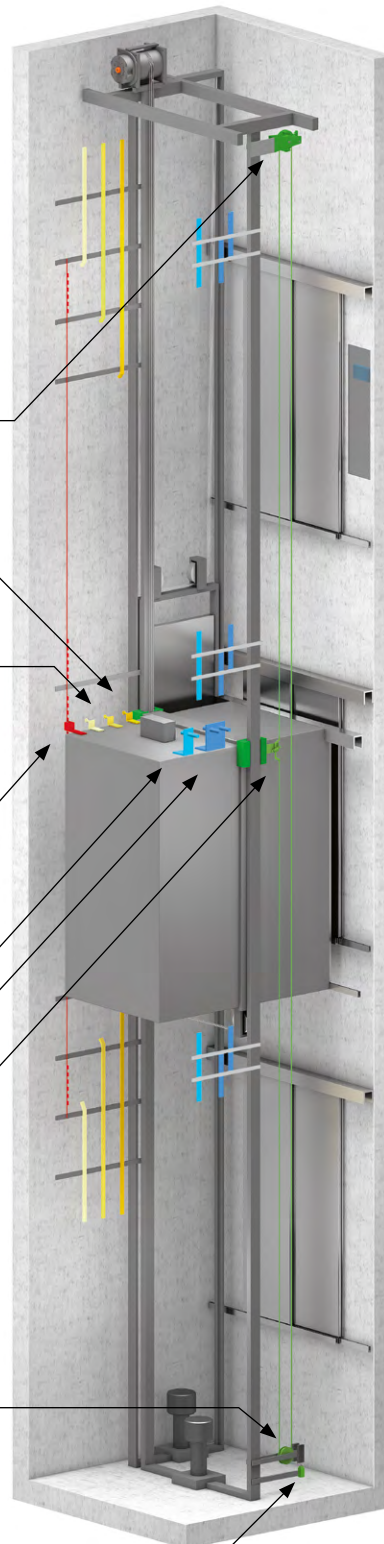

Shaft copying systems

Safe-System	LES02 / PSU02	Safety functions according to EN 81-20/21/50
--------------------	----------------------	---

Technology in detail

Modern elevator installation with Kübler Safe-System LES02 / PSU02 - digital components

With the digital shaft copying system Safe-System LES02 / PSU02 from Kübler, many of these mechanical components are replaced.

The SIL3-certified sensor detects the position of the elevator car and forwards this data for evaluation. The SIL3 certified evaluation unit (Position Supervisor Unit) PSU02 processes the sensor data for the implementation of numerous elevator and safety functions according to EN 81-20/21/50.

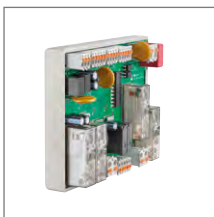

Kübler evaluation unit PSU02
(in the switch cabinet)
(alternatively at the elevator car)



Kübler sensor LES02

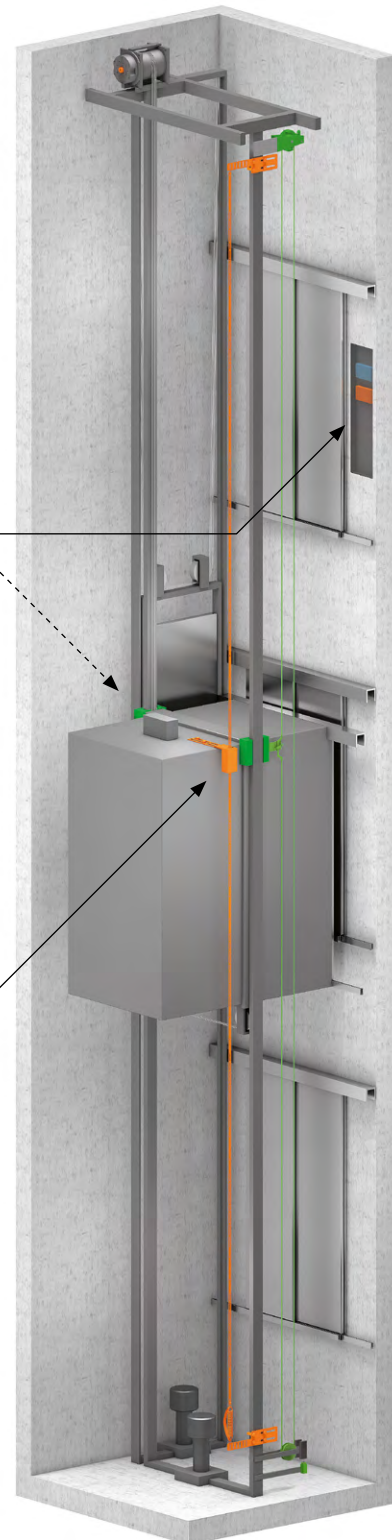

This allows, for example, functions such as emergency limit switch, delay control, door override or inspection switch to be implemented in the case of a shortened shaft head or shaft pit in accordance with EN 81-21.

Shaft copying systems

Safe-System	LES02 / PSU02	Safety functions according to EN 81-20/21/50
--------------------	----------------------	---

Technology in detail

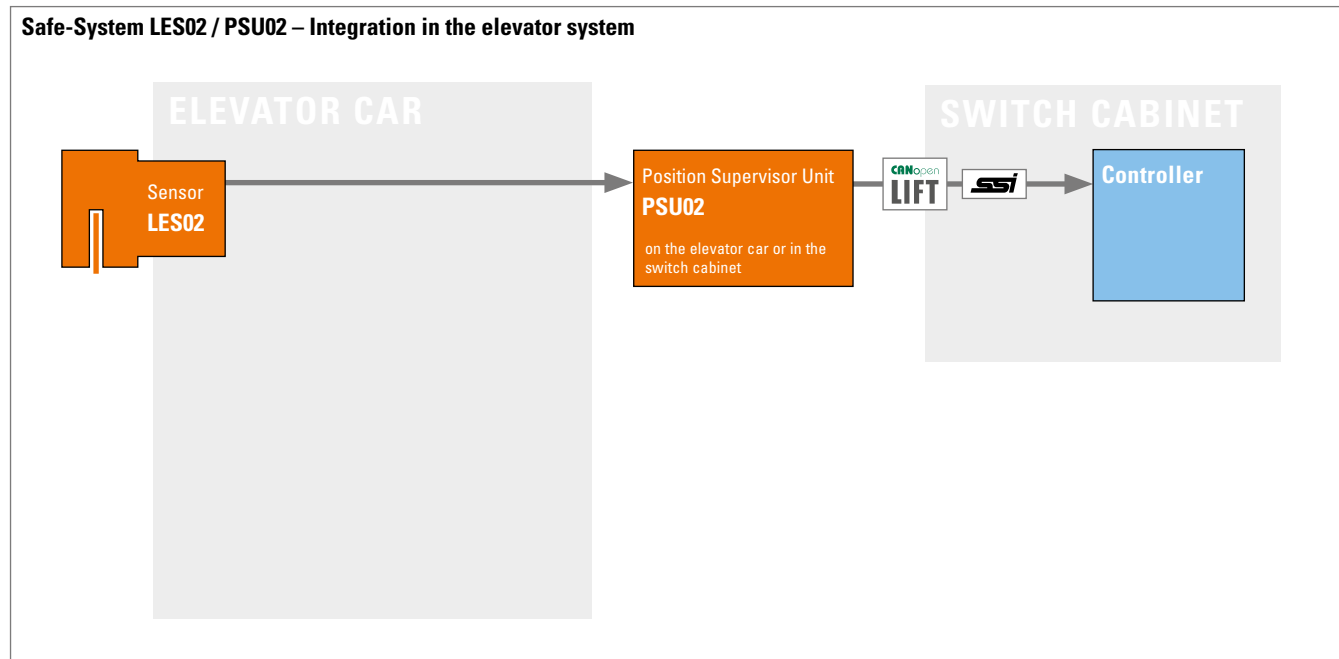

Safe-System

LES02 / PSU02

Safety functions according to EN 81-20/21/50

Technology in detail

Coded band fastening with Mounting Kit LES.MK

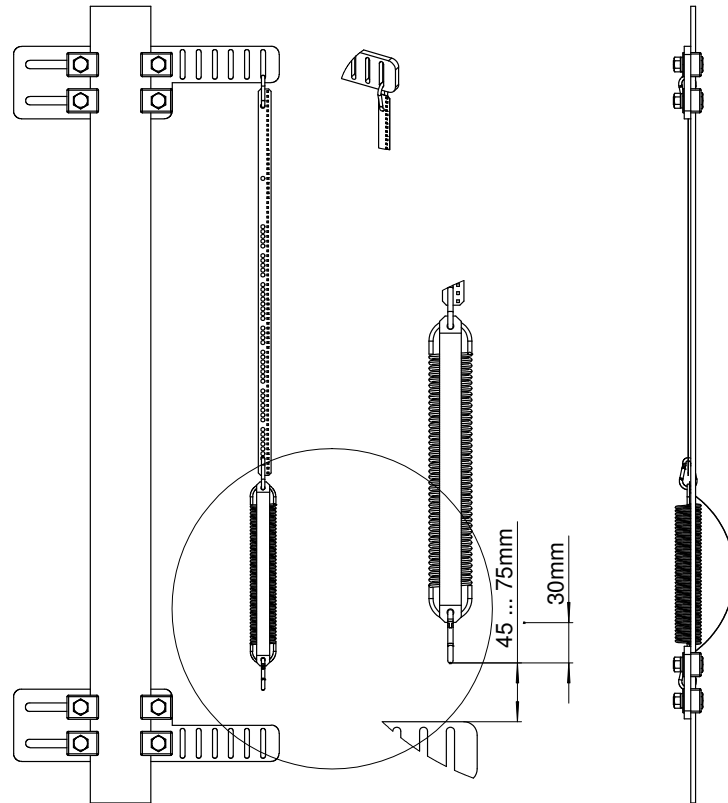

Shaft copying systems

Safe-System	LES02 / PSU02	Safety functions according to EN 81-20/21/50
--------------------	----------------------	---

Order code Sensor	8.LES02 Type	.X a	1 b	X c	.11 d	11
------------------------------	------------------------	-----------------------	----------------------	----------------------	------------------------	-----------

a *Type of mounting*
 1 = with mounting plate
 2 = without mounting plate (T-slot mounting)

b *Interface / supply voltage*
 1 = CAN / 10 ... 30 V

c *Type of connection*
 1 = cable, 3 m [9.84'], open cable end
 A = cable, special lengths, shielded, open cable end *)

d *Interface profile*
 11 = CAN (1-channel), proprietary

*) Special lengths on request: 5 m, 7 m, 10 m
 order code expansion .XXXX = length in dm
 ex.: 8.LES02.111A.1111.0050 (for cable length 5 m)

Order code Coded band, absolute	8.LEX.BA Type	.XXXX a
--	-------------------------	--------------------------

a *Measuring lengths*
 XXXX = lengths in meters
 (max. length = 392 m)

Standard lengths

0010 = 10 m	0040 = 40 m	0090 = 90 m
0015 = 15 m	0050 = 50 m	0100 = 100 m
0020 = 20 m	0060 = 60 m	0392 = 392 m
0025 = 25 m	0070 = 70 m	Intermediate lengths < 100 m as from 5 pieces,
0030 = 30 m	0080 = 80 m	> 100 m on request

Stock types

0010 = 10 m	0030 = 30 m
0015 = 15 m	0040 = 40 m
0020 = 20 m	0392 = 392 m
0025 = 25 m	

Mounting kit LES.MK	8.LES.MK.0001
--------------------------------	----------------------

Mounting kit for sensor Ants LES02

Order code PSU02	8.PSU02 Type	.1121	.2211
-----------------------------	------------------------	--------------	--------------

Evaluation unit for DIN rail mounting

- Supply voltage 24 V
- CANopen Lift, DS417 V2.2.8

Accessories		Order no.
EMC - Shield terminal	For an EMC-compliant installation of the cable	8.0000.4G06.0312