

Inclinometers

For dynamic applications 1- and 2-axis measurement	IN71	Analog
---	-------------	---------------

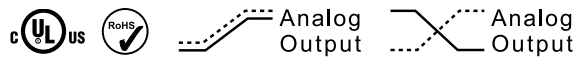

The inclinometers of the IN71 series are used to determine 2-axis inclinations in the measuring range of $\pm 85^\circ$ or 1-axis inclinations up to 360° via a sensor fusion of acceleration and rotation rate measuring cell (gyroscope). Various parameters can be customized for individual requirements (e.g. via the PACTware software). Thanks to their high robustness, the inclinometers are also ideally suited for outdoor use.



Features and benefits

- **Analog sensor with integrated IO-Link communication**
 - Configurable interfaces
 - Parameterization via IO-Link
 - Redundant / counter-rotating signals possible (1-axis)
- **“Easy-Teach” settings via Teach Adapter**
 - Reset to factory setting
 - Center of the measurement as well as start and end point for 1-axis measurement
- **Individual setting options via IO-Link Master**

In addition to the „Easy-Teach“ functions:

 - Switching the spirit level function on/off
 - Settings on the measuring range
 - Type of output signals
 - Filter settings
- **Fast measurement result and high accuracy**

Thanks to sensor fusion of acceleration and rotation rate measuring cell (gyroscope). This also minimizes the effects of vibrations and interfering accelerations.
- **Simple start-up and diagnostics**

LED display for operating status and FDT/IODD communication as well as for setting the center point position (spirit level function).
- **Precise measurement even under harsh environmental conditions**
 - Temperature range $-40^\circ\text{C} \dots +85^\circ\text{C}$ and protection level IP68 / IP69k
 - Protection against the influence of salt spray and rapid temperature changes

Order code	8.IN71.17X1.112
1-axis	Type a b

a Measuring range
7 = $0^\circ \dots 360^\circ$ ($\pm 180^\circ$)

b Analog interface (as factory setting)
1 = 4 ... 20 mA
5 = 0 ... 10 V

Stock types
8.IN71.1711.112
8.IN71.1751.112





Order code	8.IN71.2XX1.112
2-axis	Type a b

a Measuring range
1 = $\pm 10^\circ$
2 = $\pm 15^\circ$
A = $\pm 20^\circ$
3 = $\pm 30^\circ$
4 = $\pm 45^\circ$
5 = $\pm 60^\circ$
6 = $\pm 85^\circ$

b Analog interface (as factory setting)
1 = 4 ... 20 mA
5 = 0 ... 10 V

Stock types
8.IN71.2111.112 8.IN71.2211.112
8.IN71.2411.112 8.IN71.2611.112
8.IN71.2651.112 8.IN71.2A11.112

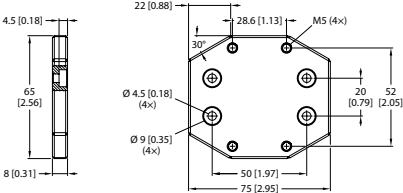
Inclinometers

For dynamic applications 1- and 2-axis measurement		IN71	Analog
Accessories			Order no.
Teach adapter 	for activating the control inputs for the following functions: - Reset to factory setting - Center point of the measurement - Start and end point for 1-axis measurement		05.TX40.1
IO-Link Master USB 	For parameterizing device settings via FDT/IODD communication. USB interface for easy connection to a PC and for power supply. Can only be used for IN61 in conjunction with adapter cable 05.00.60H1.H4H2.01M5.S004.		I0L1A. 1K1341.ZZ1UU1
Adapter cable 	For connecting the sensor to the IO-Link Master USB.		05.00.60H1.H4H2.01M5.S004
Adapter plate 	For using existing mounting holes when replacing with an IS40 inclinometer		8.0010.4066.0000
EMC shield terminal 	For an EMC-compliant installation of the cable - top-hat rail mounting - spring steel, galvanized - shield diameter 3.0 ... 12.0 mm		8.0000.4G06.0312
Cables and connectors			Order no.
Preassembled cables	M12 female connector with coupling nut, 5-pin, A coded, straight single ended 2 m [6.56'] PVC cable		05.00.6021.E211.002M
Connectors	M12 female connector with coupling nut, 5-pin, A coded, straight (metal) M12 female connector with coupling nut, 5-pin, A coded, straight (stainless steel V4A)		8.0000.5116.0000 8.0000.5116.0000.V4A

Further Kübler accessories can be found at: kuebler.com/accessories
 Further Kübler cables and connectors can be found at: kuebler.com/connection-technology

Inclinometers

**For dynamic applications
1- and 2-axis measurement** **IN71** **Analog**

Technical data

General data 1-axis measurement	
Measuring range	0 ... 360°
Resolution	16 bit
Repeat accuracy	≤ 0.03 % v. E.
Temperature drift	≤ ± 0.006 %/K
Linearity deviation	≤ ± 0.15%
Accuracy (at 25°C)	≤ ± 0.54°

General data 2-axis measurement	
Measuring range (max.)	-85 ... +85°
Resolution	16 bit
Repeat accuracy	≤ 0.06 % v. E.
Temperature drift	≤ ± 0.012 %/K
Linearity deviation	≤ ± 0.25%
Accuracy (at 25°C)	≤ ± 0.1° depending on the measuring range

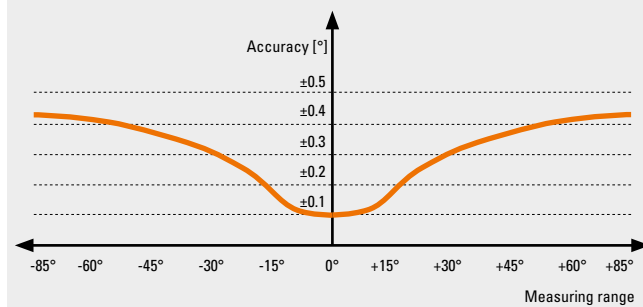

Specifications for preset measuring ranges (see order code Ⓐ)				
Measuring range	Repeat accuracy	Temperature drift	Linearity deviation	Accuracy
±10°	≤ 0.50 % v. E.	≤ ± 0.1 %/K	≤ ± 0.5 %	≤ ± 0.10°
±15°	≤ 0.65 % v. E.	≤ ± 0.07 %/K	≤ ± 0.5 %	≤ ± 0.15°
±20°	≤ 0.50 % v. E.	≤ ± 0.05 %/K	≤ ± 0.5 %	≤ ± 0.20°
±30°	≤ 0.35 % v. E.	≤ ± 0.04 %/K	≤ ± 0.45 %	≤ ± 0.27°
±45°	≤ 0.12 % v. E.	≤ ± 0.025 %/K	≤ ± 0.4 %	≤ ± 0.36°
±60°	≤ 0.085 % v. E.	≤ ± 0.020 %/K	≤ ± 0.3 %	≤ ± 0.36°
±85°	≤ 0.060 % v. E.	≤ ± 0.012 %/K	≤ ± 0.25 %	≤ ± 0.43°

Mechanical characteristics	
Electrical connection	M12 connectors, 5-pin
Weight	89 g [3.14 oz]
Protection acc. to EN 60529	IP68 / IP69k
Working temperature range	-40 °C ... +85 °C [-40 °F ... +185 °F]
Material	housing Plastic, polyetherimide
Vibration resistance (EN 60068-2-6)	20 g; 5 h/axis; 3 axes
Shock resistance (EN 60068-2-27)	150 g; 4 ms 1/2 sine
MTTF	297 years
Dimensions	71.6 x 62.6 x 20 mm [2.82 x 2.46 x 0.79"]

Electrical characteristics	
Supply voltage	15 ... 30 V DC
Residual ripple	≤ 10 % U _{ss}
Isolation test voltage	≤ 0.5 kV
Short-circuit protection	yes
Wire breakage / Reverse polarity protection	yes
Current consumption	max. 80 mA

Interface characteristics analog output	
Current/voltage output	factory setting 4 ... 20 mA or 0 ... 10 V adjustable 0 ... 20 mA 0.1 ... 4.9 V / 0.5 ... 4.5 V / 0 ... 5 V
Load resistance voltage output	≥ 4.7 kΩ
Load resistance current output	≤ 0.4 kΩ

Approvals	
UL compliant in accordance with	File-Nr. E539414
CE compliant in accordance with	
EMV Directive	2014/30/EU
RoHS Directive	2011/65/EU

Inclinometers

For dynamic applications 1- and 2-axis measurement	IN71	Analog
---	-------------	---------------

Terminal assignment

Interface	M12 connector, male contacts, 5-pin, A-coded						
Analog	Signal 1-axis:	+V	Out _{ccw}	0 V	Out _{cw}	Teach/IOL	
	Signal 2-axis:	+V	Out y	0 V	Out x	Teach/IOL	
	Pin:	1	2	3	4	5	

- +V : Supply voltage +V DC
- 0 V : Supply voltage ground GND (0 V)
- Out x / Out y : Current/voltage output for 2-axis measurement
- Out_{ccw} / Out_{cw} : Redundant current/voltage output for 1-axis measurement
- Teach/IOL : Teach input/ IO-Link Master USB input

Dimensions

Dimensions in mm [inch]

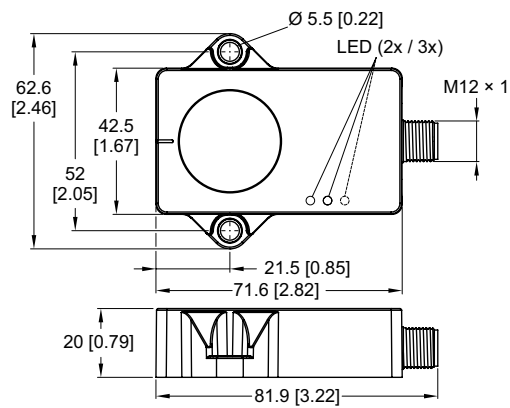

Inclinometers

For dynamic applications 1- and 2-axis measurement	IN71	Analog
---	-------------	---------------

Technology in detail

Fast measurement results and maximum accuracy thanks to sensor fusion of acceleration and rotation rate measurement

Acceleration measurement

In the acceleration measuring cell, the absolute angular position is determined capacitively in relation to the gravity acceleration \vec{g} .

The displacement **2** of a test mass **1** changes the distance and therefore also the capacity **F** between fixed **3** and moving **4** electrodes in the measuring cell. This measured capacity is directly related to the inclination of the sensor.

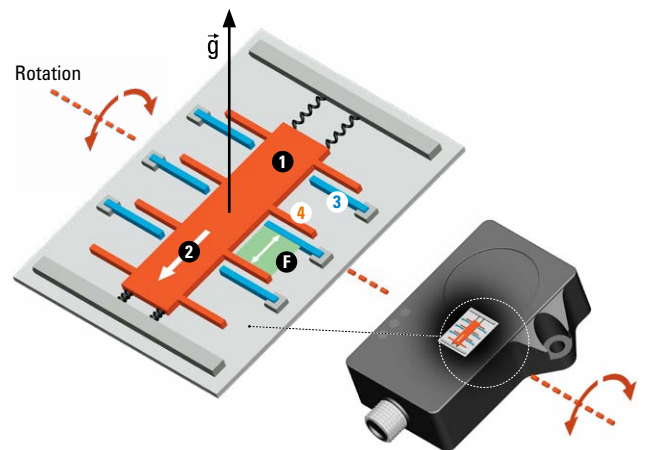
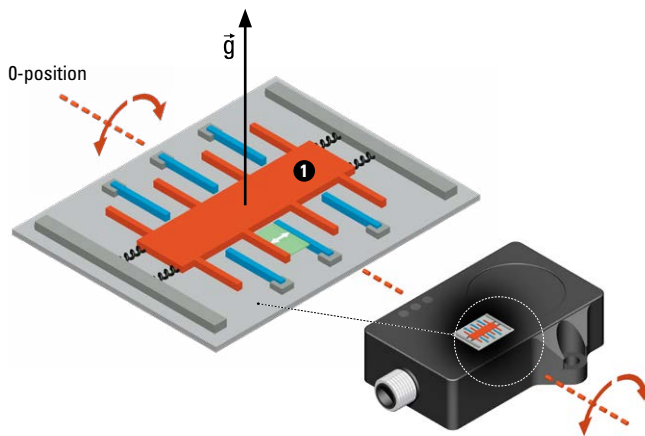

Rotation rate measurement

In the rotation rate measuring cell (gyroscope), the Coriolis force resulting from a rotation is evaluated in order to determine the angle of rotation in relation to the starting position.

This displacement is also determined by the change in capacity **F** between fixed and moving electrodes and is directly related to the rotational speed (rotation rate).

An arrangement of frame **2** and test mass **1** is in a permanent linear movement **3** (oscillating).

The angle of rotation is determined from the speed of rotation and the duration of rotation.

If this system is brought into rotation, this results in a force (Coriolis force) **4** that leads to a displacement of the test mass.

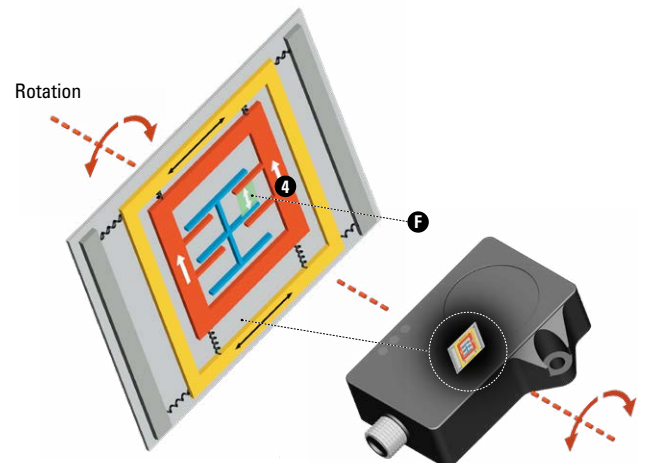
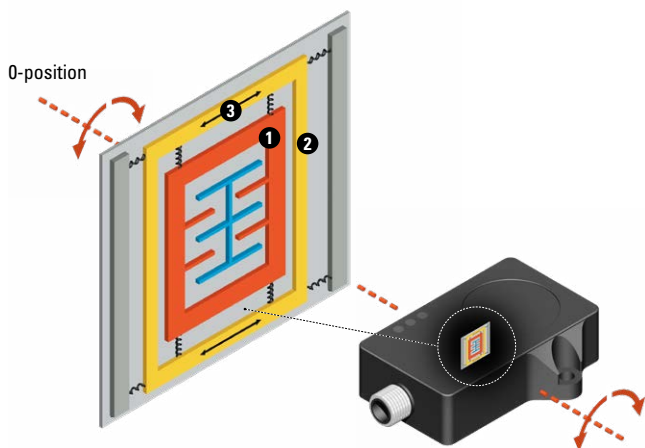

Intelligent sensor fusion of acceleration and rotation rate measurement

Both measured values are combined in the inclinometers for dynamic applications. The effect is even faster and more accurate output results.



Inclinometers

For dynamic applications
1- and 2-axis measurement

IN71

Analog

Technology in detail

Comparison static inclinometer (accelerometer only) - dynamic inclinometer (sensor fusion)

Fast measurement

Inaccuracies due to the inertia of the test mass can be compensated for in acceleration measurement via filters. However, there is a time delay Δt for the output of the measurement result. This time delay is minimized with sensor fusion.

Acceleration measuring cell (static)

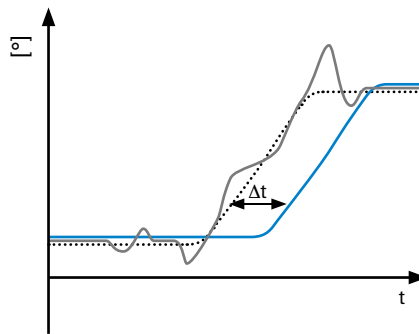

Sensor fusion (dynamic)

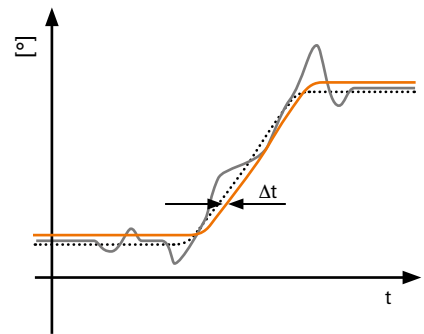

Accurate measurement

The sensor fusion leads to more accurate measurement results when changing direction quickly.

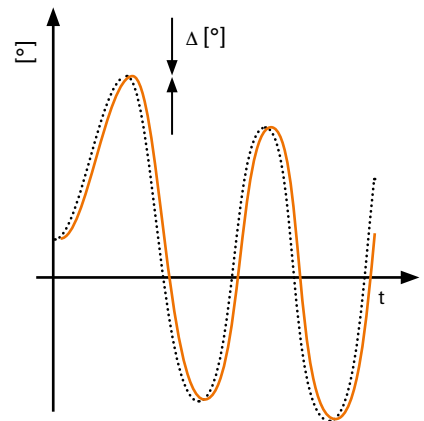
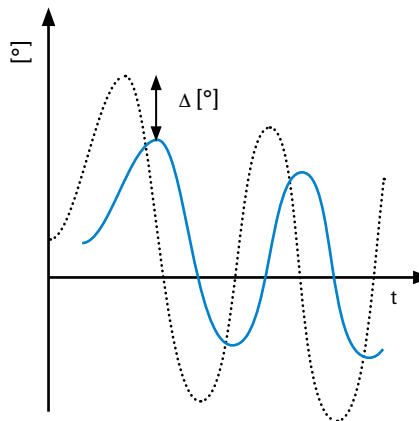

- Actual movement
- Detected data of the acceleration measurement
- Filtered measurement results of the acceleration measurement
- Result sensor fusion of acceleration and rotation rate measurement

Easy start-up

Operating status – LED green

Permanent light	Appliance ready for operation
Blinking	FDT/IODD communication



Spirit level function – LED(s) yellow

Permanent light	Center position reached
Blinking with increasing frequency	Approaching the center position
Blinking with decreasing frequency	Move away from center position

1-axis = 2 LEDs



2-axis = 3 LEDs



Inclinometers

For dynamic applications 1- and 2-axis measurement	IN71	Analog
---	-------------	---------------

Technology in detail

Quick setting options via the Easy-Teach function with teach adapter

Connection
The teach adapter **2** is connected between the sensor **1** and the connection cable to the application **4**.

Parameterization
The following settings can be made quickly and easily by pressing the toggle switch **3**:

- Start/end point of the measuring range (for 1-axis measurement)
- Midpoint of the measuring range
- Reset to factory setting

Individual setting options via FDT/IODD with IO-Link Master USB

Connection
The inclinometer **1** is or will be disconnected from the application **3**. The IO-Link Master USB **2** is connected to the inclinometer with the adapter cable **4** and connected to the PC via the USB interface **5**. The following parameters can be set using the appropriate software **6** (e.g. PACTware):

Setting options	
Spirit level function	Can be activated as an assembly aid
Easy Teach	Parameterization via Easy Teach can be deactivated
Direction of rotation	Setting the direction of rotation of the axes. Output of the increasing analog values clockwise or counterclockwise.
Analog output	Possible analog outputs independent of the factory setting: Current outputs: 0 ... 20 mA 4 ... 20 mA Voltage outputs: 0.1 ... 4.9 V 0.5 ... 4.5 V 0 ... 5 V 0 ... 10 V
Starting point / End point	The start/end point of the output characteristic curve can be defined by entering the angle or the current tilt angle; for 2-axis devices, a different measuring range can be set using this function.
Filters	Balanced / Very slow / Slow Fast / Very fast (factory setting)