

Inclinometers

For static applications 1- and 2-axis measurement	IN62	2 switching outputs (PNP/NPN)
--	-------------	--------------------------------------

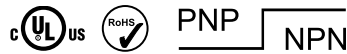

The inclinometers in the IN62 series are used to detect 2-axis inclinations in the measuring range of $\pm 85^\circ$ or 1-axis inclinations of up to 360° via an acceleration measuring cell. Various parameters can be customized for individual requirements (e.g. via the PACTware software). Thanks to their high robustness, the inclinometers are also ideally suited for outdoor use.





Features and benefits

- Two freely parameterizable switching outputs/ranges (PNP/NPN)**
 - Simple setting of the required end position / ranges via integrated IO-Link interface.
 - Two different switching ranges or redundant output of the same switching range possible
- Individual setting options via IO-Link Master**
 - Reset to factory setting
 - Configuration of the switching outputs - NC or NO contact, switching range via input or current tilt angle.
 - Switching the spirit level function on/off
 - Filter settings
- Simple start-up and diagnostics**
 - LED display for operating status and FDT/IODD communication as well as for setting the center point position (spirit level function).
- Precise measurement even under harsh environmental conditions**
 - Temperature range $-40^\circ\text{C} \dots +85^\circ\text{C}$ and protection level IP68 / IP69k
 - Protection against the influence of salt spray and rapid temperature changes

Order code 1-axis	8.IN62.1711.114 Type a b
<p>a Measuring range 7 = $0^\circ \dots 360^\circ$ ($\pm 180^\circ$)</p> <p>b Switching outputs 1 = PNP + NPN</p> <p>Stock types 8.IN62.1711.114</p>	

Order code 2-axis	8.IN62.2611.114 Type a b
<p>a Measuring range 6 = $\pm 85^\circ$</p> <p>b Switching outputs 1 = PNP + NPN</p> <p>Stock types 8.IN62.2611.114</p>	

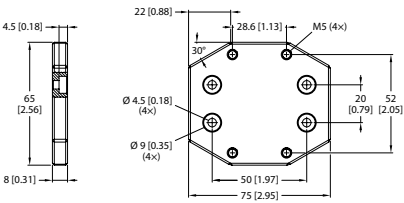
Inclinometers

For static applications 1- and 2-axis measurement		IN62	2 switching outputs (PNP/NPN)
Accessories			Order no.
IO-Link Master USB 	For parameterizing device settings via FDT/IODD communication. USB interface for easy connection to a PC and for power supply. Adapter cable suitable for IN62: 05.00.6061.6462.002M (see below)		IOL1A. 1K1341.ZZ1UU1
	Adapter plate	For using existing mounting holes when replacing with an IS40 inclinometer 	8.0010.4066.0000
EMC shield terminal 	For an EMC-compliant installation of the cable - top-hat rail mounting - spring steel, galvanized - shield diameter 3.0 ... 12.0 mm		8.0000.4G06.0312
Cables and connectors			Order no.
Preassembled cables	M12 female connector with coupling nut, 4-pin, A coded, straight single ended 2 m [6.56'] PUR cable		05.00.6061.6211.002M
	M12 female connector with coupling nut, 4-pin, A coded, straight M12 male connector with external thread, 4-pin, A coded, straight 2 m [6.56'] PUR cable		05.00.6061.6462.002M
Connectors	M12 female connector with coupling nut, 4-pin, A coded, straight (plastic)		05.B8141-0

Further Kübler accessories can be found at: kuebler.com/accessories

Further Kübler cables and connectors can be found at: kuebler.com/connection-technology

Inclinometers

For static applications 1- and 2-axis measurement	IN62	2 switching outputs (PNP/NPN)
--	-------------	--------------------------------------

Technical data

General data 1-axis measurement	
Measuring range	0 ... 360°
Resolution	0.01°
Repeat accuracy	≤ 0.05 % v. E.
Temperature drift	≤ ±0.006 %/K
Linearity deviation	≤ ±0.2%
Accuracy (at 25°C)	≤ ±0.72°

General data 2-axis measurement	
Measuring range (max.)	-85 ... +85°
Resolution	0.01°
Repeat accuracy	≤ 0.1 % v. E.
Temperature drift	≤ ±0.012 %/K
Linearity deviation	≤ ±0.2%
Accuracy (at 25°C)	≤ ±0.1° depending on the measuring range

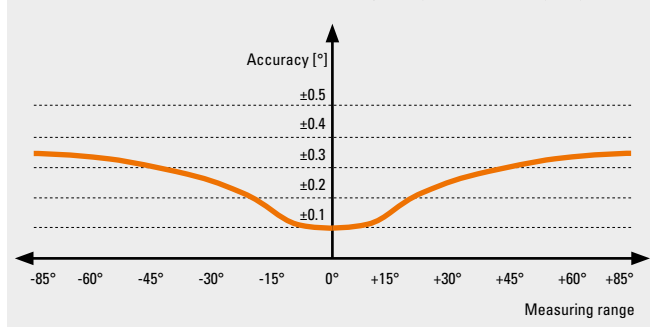

Mechanical characteristics	
Electrical connection	M12 connectors, 4-pin
Weight	89 g [3.14 oz]
Protection acc. to EN 60529	IP68 / IP69k
Working temperature range	-40 °C ... +85 °C [-40 °F ... +185 °F]
Material	housing Plastic, polyetherimide
Vibration resistance (EN 60068-2-6)	20 g; 5 h/axis; 3 axes
Shock resistance (EN 60068-2-27)	150 g; 4 ms 1/2 sine
MTTF	548 years
Dimensions	71.6 x 62.6 x 20 mm [2.82 x 2.46 x 0.79"]

Electrical characteristics	
Supply voltage	10 ... 30 V DC
Residual ripple	≤ 10 % U _{ss}
DC rated operational current	≤ 200 mA
Isolation test voltage	≤ 0.5 kV
Wire breakage / Reverse polarity protection	yes
Current consumption	max. 50 mA

Switching outputs	
Output function	NO/NC, PNP/NPN

Approvals	
UL compliant in accordance with	File-Nr. E539414
CE compliant in accordance with	
EMV Directive	2014/30/EU
RoHS Directive	2011/65/EU

Inclinometers

For static applications
1- and 2-axis measurement

IN62

2 switching outputs (PNP/NPN)

Terminal assignment

Interface	M12 connector, male contacts, 4-pin, A-coded					
Switching outputs	Signal:	+V	Out 2	0 V	Out 1/IOL	
	Pin:	1	2	3	4	

+V : Supply voltage +V DC
 0 V : Supply voltage ground GND (0 V)
 Out 1 / Out 2 : Switching outputs
 IOL : IO-Link Master USB input

Dimensions

Dimensions in mm [inch]

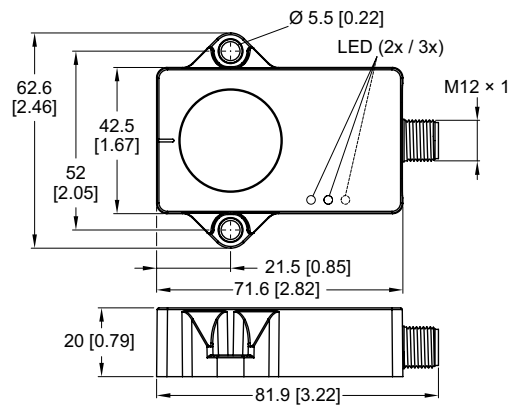

Inclinometers

For static applications 1- and 2-axis measurement	IN62	2 switching outputs (PNP/NPN)
--	-------------	--------------------------------------

Technology in detail

Exact angular position via acceleration measurement

Acceleration measurement

In the acceleration measuring cell, the absolute angular position is determined capacitively in relation to the gravity acceleration \vec{g} .

The displacement **2** of a test mass **1** changes the distance and therefore also the capacity **F** between fixed **3** and moving **4** electrodes in the measuring cell. This measured capacity is directly related to the inclination of the sensor.

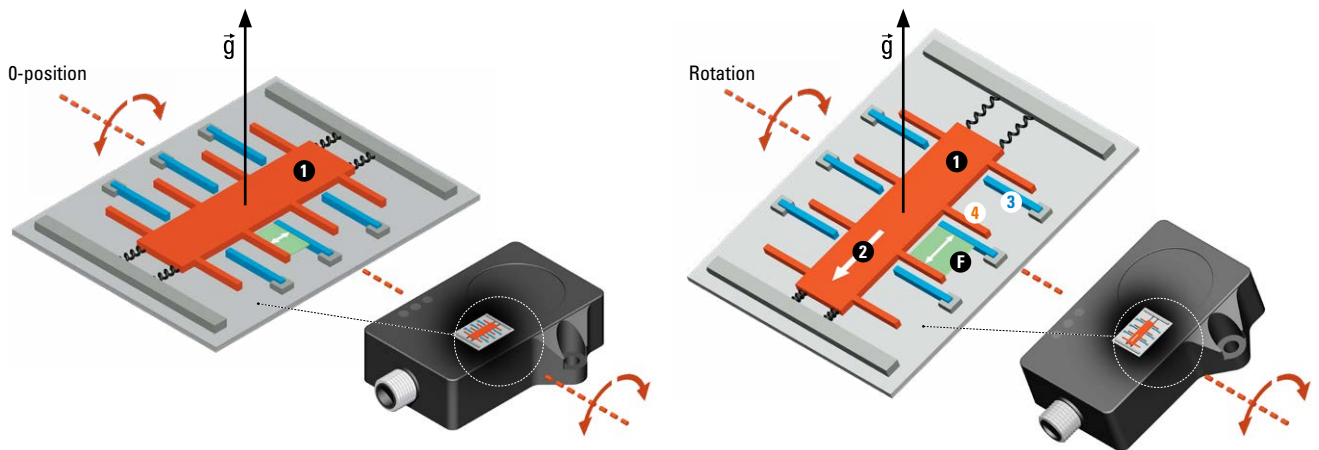

Optimization of the measurement using filter functions

The inertia of the test mass, particularly in the case of fast or rapidly changing rotations and vibrations, can lead to inaccuracies in the detected measurement data **b** compared to the actual movement **a**. To compensate for these undesirable effects, various filters **c** + **d** can be parameterized in the inclinometer.

Restrictions due to filters

However, this leads to a time delay ($\Delta t_c + \Delta t_d$) for the output of the measurement result (the more precise the desired measurement, the greater the time delay).

Further optimization with dynamic inclinometers

This time delay is not relevant for many static applications (such as solar panels, crane masts, etc.). In dynamic applications (e.g. vehicles in motion), however, this can lead to problems, as a reaction to the movement can only occur with a delay. In this case, it is advisable to use a dynamic inclinometer IN72 with intelligent sensor fusion from Kübler for further optimization of the measurement result.

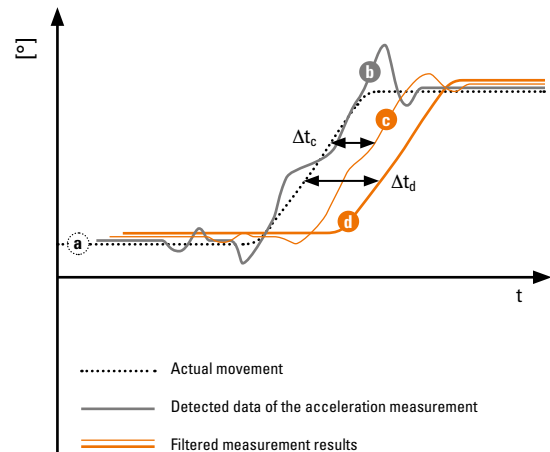

Inclinometers

For static applications
1- and 2-axis measurement

IN62

2 switching outputs (PNP/NPN)

Technology in detail

Individual setting options via FDT/IODD with IO-Link Master USB

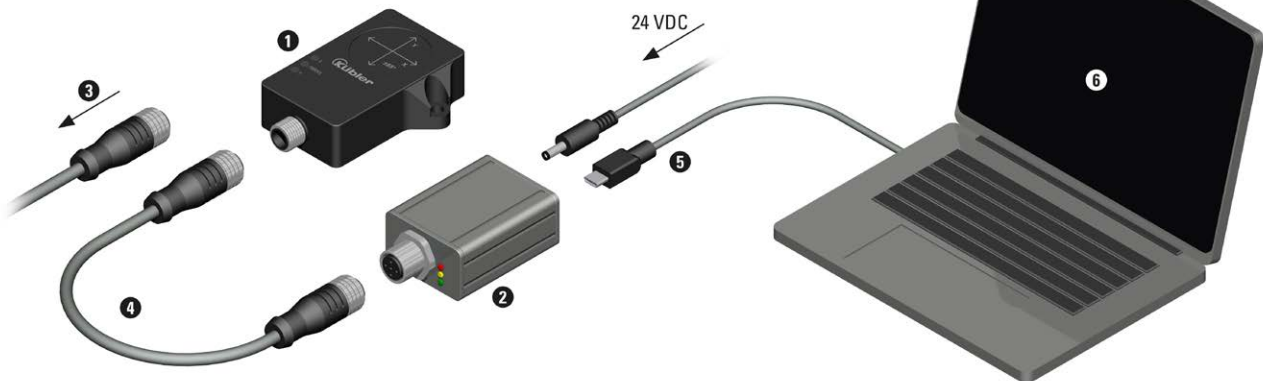

Connection

The inclinometer **1** is or will be disconnected from the application **3**. The IO-Link Master USB **2** is connected to the inclinometer with the adapter cable **4** and connected to the PC via the USB interface **5**. The following parameters can be set using the appropriate software **6** (e.g. PACTware):

Setting options

Spirit level function	Can be activated as an assembly aid
Center point	Set current inclination as new measuring range center point
Switching outputs	Configurable as PNP or NPN
Axes	The detection axis can be adjusted (2-axis devices)
Starting point / End point	The start and end point of the switching window can be set by input or via the current tilt angle. The switching area must be > 1°.
Hysteresis	The area of the hysteresis behavior can be set. The hysteresis must be smaller than the switching area.
Filters	Balanced (factory setting) Slow

Easy start-up

Operating status – LED green

Permanent light	Appliance ready for operation
Blinking	FDT/IODD communication

Switching status – LEDs yellow

Permanent light	Switching output active
-----------------	-------------------------

Spirit level function – LEDs yellow

Permanent light	Center position reached
Blinking with increasing frequency	Approaching the center position
Blinking with decreasing frequency	Move away from center position



1-axis = 3 LEDs

2-axis = 3 LEDs



Inclinometers

For static applications 1- and 2-axis measurement	IN62	2 switching outputs (PNP/NPN)
--	-------------	--------------------------------------

Technology in detail

Two freely parameterizable switching outputs/ranges (Example)

1-axis measuring / two identical switching ranges (redundancy)

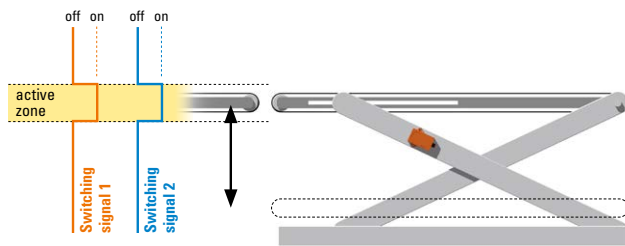

1-axis measuring / two different switching ranges

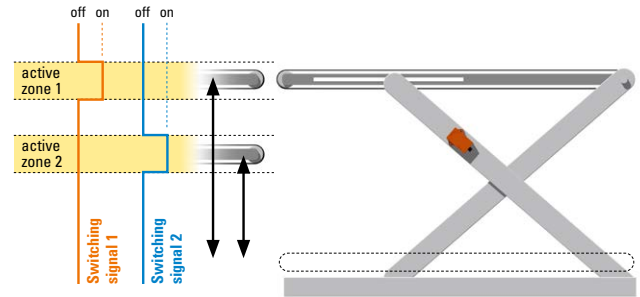

2-axis measuring / switching range X-axis

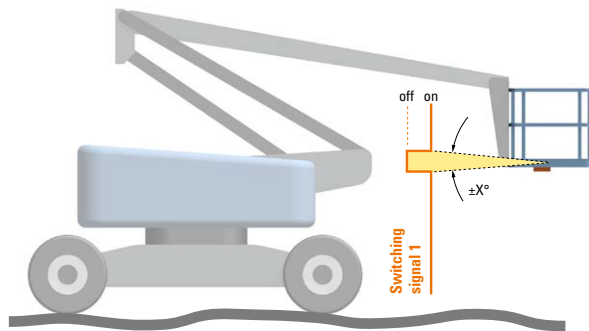

2-axis measuring / switching range Y-axis

