

# Linear measuring technology

<b>Draw-wire encoder C60</b>	<b>Robust-Line</b>	<b>Measuring length max. 4 m</b>
------------------------------	--------------------	----------------------------------

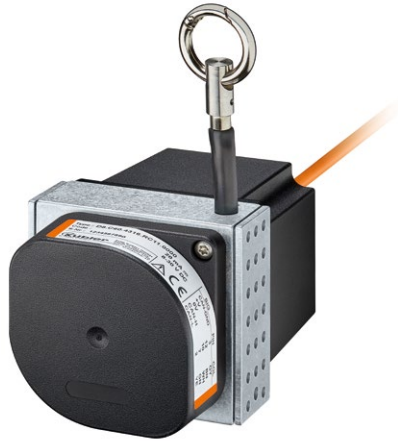

With its extremely robust design, the high protection class IP69k and the wide temperature range up to -40 °C ... +85 °C the draw-wire encoders C60 are specially developed for outdoor applications.

Their flexibility and adaptability reflects in the wide range of housing and wire types, the long measuring range and the various interfaces. The possibility of redundancy must be particularly pointed out.



Analog output

CANopen

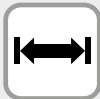

Long service life



-40° ... +85°C



IP69k



Redundancy



V4A

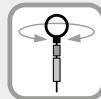

Integrated swivel



For outdoor applications



3 housing types

## Robust

- Protection level up to IP69k and wide temperature range up to -40 °C ... +85 °C.
- The titanium-anodized aluminum housing and the stainless steel wires allow using the mechanics even in harsh conditions.
- Wire diameter (stainless steel V4A, plastic coated) up to  $\varnothing$  1 mm - ideal for outdoor applications.

## Versatile

- Measuring length up to 4 m.
- Redundant outputs (mA, V, R, CANopen).
- The right measuring wire and the right wire fastening for every application.
- Linearity up to  $\pm 0.1$  % of the measuring range.
- Various constructions: open, closed housing or housing with perforated plate cover.

**Draw-wire encoder C60**      **Robust-Line**      **Measuring length max. 4 m**

**Order code**      **D8.C60** . **XXXXX** . **XXX** **X** . **0000** . **XXXX**  
Type      a b c d e f g

**a** *Measuring length*

- 2 = 1.0 m
- 3 = 1.5 m
- 4 = 2.0 m
- 5 = 2.5 m
- 6 = 3.0 m
- 7 = 3.5 m
- 8 = 4.0 m

**b** *Wire types (stainless steel V4A, plastic coated)*

- 1 = ø 0.5 mm
- 2 = ø 0.7 mm
- 3 = ø 1.0 mm (not for measuring length 3.5 ... 4 m)

**c** *Linearity*

- 1 = standard linearity 0.5 %
- 2 = improved linearity 0.25 %
- 3 = improved linearity 0.1 %

**d** *Housing*

- 1 = open housing
- 3 = housing with perforated plate cover
- 6 = closed housing

**e** *Single sensor / supply voltage*

- A11 = 4 ... 20 mA / 12 ... 30 V DC
- A22 = 0 ... 10 V / 12 ... 30 V DC
- A33 = 1 kΩ / max. 30 V DC
- A44 = 0.5 ... 4.5 V / 8 ... 30 V DC
- A55 = 0 ... 5 V / 8 ... 30 V DC
- CC1 = CANopen / 8 ... 30 V DC

*Redundant sensor / supply voltage*

- R11 = 2 x 4 ... 20 mA / 12 ... 30 V DC
- R22 = 2 x 0 ... 10 V / 12 ... 30 V DC
- R33 = 2 x 1 kΩ / max. 30 V DC
- R44 = 2 x 0.5 ... 4.5 V / 8 ... 30 V DC
- R55 = 2 x 0 ... 5 V / 8 ... 30 V DC
- RC1 = 2 x CANopen / 8 ... 30 V DC

**f** *Type of connection / protection level sensor*

*Cable connection, standard lengths<sup>1)</sup>*

- 1 = axial cable, 2 m [6.56'] TPE / IP69k
- 2 = axial cable, 2 m [6.56'] TPE / IP67
- C = axial cable, 5 m [16.40'] TPE / IP69k
- E = axial cable, 5 m [16.40'] TPE / IP67
- D = axial cable, 10 m [32.81'] TPE / IP69k
- F = axial cable, 10 m [32.81'] TPE / IP67

*Connector*

- 3 = axial M12 connector / IP67
- 4-pin for sensor type A11 ... A55
- 5-pin for sensor type CC1 ... RC1
- 8-pin for sensor type R11 ... R55

**g** *Extended order options (optional)*

*Wire fastenings (standard = carabiner ring)*

- V001 = M4 thread
- V002 = eyelet
- V007 = clip

*Extended temperature range -40 °C ... +85 °C*

*(only in combination with the standard linearity 0.5 %, c = 1)*

- V003 = with carabiner ring
- V004 = with M4 thread
- V005 = with eyelet
- V008 = with clip

**Relationship measuring length – wire types – linearity**

Measuring length	[m]	1.0			1.5			2.0			2.5			3.0			3.5			4.0			
		order code a 2			order code a 3			order code a 4			order code a 5			order code a 6			order code a 7			order code a 8			
Wire type	ø [mm]	0.5	0.7	1.0	0.5	0.7	1.0	0.5	0.7	1.0	0.5	0.7	1.0	0.5	0.7	1.0	0.5	0.7	0.5	0.7			
	order code b	1	2	3	1	2	3	1	2	3	1	2	3	1	2	3	1	2	1	2			
Standard linearity ± 0.5 %	order code c = 1	±0.5 %			±0.5 %			±0.5 %			±1 %			±0.5 %			±1 %			±0.5 %		±1 %	
Improved linearity ±0.25 %	order code c = 2	✓	✓	✓	✓	✓	✓	✓	✓	–	✓	–	–	✓	–	–	–	–	–	–	–		
Improved linearity ±0.1 %	order code c = 3	✓	✓	✓	✓	✓	✓	✓	✓	–	✓	–	–	✓	–	–	–	–	–	–	–		

✓ feasible / – not feasible

1) Other cable length on request.

# Linear measuring technology

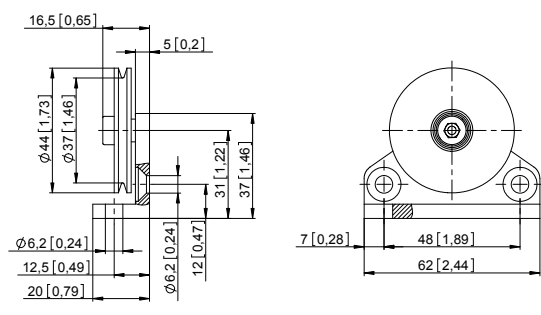
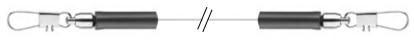
Draw-wire encoder C60	Robust-Line	Measuring length max. 4 m
<b>Accessories for draw-wire encoder</b>		
<b>Guide pulley for wire type 1</b> (0.5 mm)	Dimensions in mm [inch]  Technical data: - mounting bracket (anodized alum.) - guide pulley (plastic POM) - ball bearing (type 696-2R5)	Scope of delivery: - 2 x countersunk screws for lateral fixing - 2 x hexagonal screws for fixing on a flat surface  <b>8.0000.7000.0045<sup>1)</sup></b>
 		
<b>Extension cable</b> (further on request)	 0.5 m with clip 1.0 m with clip 2.0 m with clip	<b>8.0000.7000.0051</b> <b>8.0000.7000.0052</b> <b>8.0000.7000.0054</b>
<b>Cables and connectors</b>		
<b>Preassembled cables</b>	M12 female connector with coupling nut, 4-pin, A coded, straight single ended 2 m [6.56'] PUR cable  M12 female connector with coupling nut, 5-pin, A coded, straight single ended 2 m [6.56'] PVC cable  M12 female connector with coupling nut, 8-pin, A coded, straight single ended 2 m [6.56'] PVC cable	<b>05.00.6061.6211.002M</b>  <b>05.00.6081.2211.002M</b>  <b>05.00.6041.8211.002M</b>
<b>Connectors</b>	M12 female connector with coupling nut, 4-pin, A coded, straight (plastic) M12 female connector with coupling nut, 5-pin, A coded, straight (metal/plastic) M12 female connector with coupling nut, 8-pin, A coded, straight (metal)	<b>05.B8141-0</b> <b>05.B-8151-0/9</b> <b>05.CMB 8181-0</b>

Further Kübler cables and connectors can be found at: [kuebler.com/connection-technology](http://kuebler.com/connection-technology)

1) Stock types.

# Linear measuring technology

<b>Draw-wire encoder C60</b>	<b>Robust-Line</b>	<b>Measuring length max. 4 m</b>
------------------------------	--------------------	----------------------------------

## Technical data

General technical data	
<b>Standard linearity</b>	±0.5 %
<b>Improved linearity</b>	±0.25 % or ±0.1 %
<b>Resolution</b>	see electrical characteristics
<b>Sensor element</b>	potentiometer
<b>Output signal</b> (others on request)	4 ... 20 mA 0 ... 10 V, 0.5 ... 4.5 V, 0 ... 5 V Potentiometer CANopen
<b>Connection</b>	axial M12 connector or axial cable outlet (TPE cable), standard length 2, 5, 10 m
<b>Protection</b>	M12 connector IP67 cable IP67, IP69k
<b>Humidity</b>	max. 90 % relative, no condensing
<b>Working temperature</b>	standard -20 °C ... +85 °C [-4 °F ... +185 °F] as extended order option (s.page 6) -40 °C ... +85 °C [-40 °F ... +185 °F]
<b>Speed max.</b>	3.0 m/s
<b>Acceleration max.</b>	50 m/s <sup>2</sup>
<b>Weight</b>	up to approx. 420 g [14.82 oz] depending on measuring range and measuring wire diameter
<b>Housing</b>	aluminum, spring housing PA6
<b>Spring force</b>	min. 4 N / max. 6 N <sup>1)</sup>

Interface characteristics CANopen – Sensor type CC1, RC1	
<b>CAN specification</b>	Full CAN 2.0B (ISO11898)
<b>Communication profile</b>	CANopen CiA 301 V 4.2.0
<b>Device profile</b>	encoder, absolute linear; CiA 406 V 3.2.0
<b>Error monitoring</b>	Producer Heartbeat, Emergency Message, Node Guarding
<b>Node ID</b>	default: 7, adjustable via SDO
<b>PDO</b>	1 x TPDO, static mapping
<b>PDO functions</b>	event-triggered, time-triggered, Sync-cyclic, Sync-acyclic
<b>Transmission rate</b>	Default 250 kbit/s, 1 Mbps, 800, 500, 250, 125, 50, 20 kbps adjustable via SDO
<b>Bus connection</b>	M12 connector, 5-pin or axial cable outlet (TPE cable), standard length 2 m
<b>Integrated bus terminating resistor</b>	120 ohms ready-to-activate via SDO
<b>Bus, galvanic isolation</b>	no
<b>Supply voltage</b>	8 ... 30 V DC
<b>Current consumption</b>	typ. 10 mA at 24 V, typ. 20 mA at 12 V
<b>Measuring rate</b>	1 kHz with 16 bit resolution
<b>Resolution</b>	0.002 % of the measuring range
<b>Electrical protection</b>	Reverse polarity protection

## Electrical characteristics (analog sensor, scaled to measuring range)

Sensor type	A11 / R11 Current output	A22, R22	A44, R44 Voltage outputs	A55, R55	A33 / R33 Potentiometer
<b>Output</b>	4 ... 20 mA	0 ... 10 V	0.5 ... 4.5 V	0 ... 5 V	1 kΩ
<b>Supply voltage</b>	12 ... 30 V DC	12 ... 30 V DC	8 ... 30 V DC	8 ... 30 V DC	max. 30 V DC
<b>Recommended slider current</b>	–	–	–	–	< 1 μA
<b>Current consumption</b>	–	–	25 mA (non load)	–	–
<b>Output current</b>	max. 50 mA in case of a failure	–	max. 10 mA, min. load 10 kΩ	–	–
<b>Response time</b>	< 1 ms from 0 ... 100 % and 100 ... 0 %	–	< 3 ms from 0 ... 100 % and 100 ... 0 %	–	–
<b>Resolution</b>	theoretically unlimited, limited by the noise				
<b>Noise</b>	1.6 mA <sub>eff</sub>	–	0.5 mV <sub>eff</sub>	–	depending on the supply voltage
<b>Reverse polarity protection</b>	–	–	yes	–	–
<b>Short circuit proof</b>	–	–	yes	–	–
<b>Temperature coefficient</b>	0.0079 %/K	–	0.0037 %/K	–	±0.0025 %/K

## Characteristics measuring wire

<b>Material</b>	stainless steel V4A (1.4401), plastic coated	
<b>Measuring range</b>	∅ 0.5 mm	1 ... 4 m
	∅ 0.7 mm	1 ... 4 m
	∅ 1.0 mm	1 ... 3 m
<b>Breaking force</b>	∅ 0.5 mm	130 N
	∅ 0.7 mm	216 N
	∅ 1.0 mm	478 N
<b>Temperature coefficient</b>	16 x 10 <sup>-6</sup> K <sup>-1</sup>	

## Approvals

<b>Electromagnetic compatibility</b>	acc. to EN 61326-1, EN 61326-3-1	
<b>CE compliant in accordance with</b>	EMC Directive	2014/30/EU
	RoHS Directive	2011/65/EU

1) Depends on the measuring length.

<b>Draw-wire encoder C60</b>	<b>Robust-Line</b>	<b>Measuring length max. 4 m</b>
------------------------------	--------------------	----------------------------------

### Terminal assignment

<b>Analog sensor</b> <b>A11</b> (4 ... 20 mA)			R/I converter									
			Signal:	+V	n.c.	I <sub>out</sub>	n.c.					
	Cable <sup>1)</sup>	M12 connector, 4-pin	Core color:	BN	WH	BU	BK					
		Pin:	1	2	3	4						
<b>Analog sensor</b> <b>redundant</b> <b>R11</b> (2 x 4 ... 20 mA)			R/I-Wandler 1		R/I-Wandler 2							
			Signal:	+V <sub>1</sub>	I <sub>out 1</sub>	+V <sub>2</sub>	I <sub>out 2</sub>	n.c.	n.c.	n.c.	n.c.	
	Cable <sup>1)</sup>	M12 connector, 8-pin	Core color:	WH	GN	GY	BU	BN	YE	PK	RD	
		Pin:	1	3	5	7	2	4	6	8		

<b>Analog sensor</b> <b>A22</b> (0 ... 10 V DC) <b>A44</b> (0.5 ... 4.5 V) <b>A55</b> (0 ... 5 V)			R/U converter									
			Signal:	+V	U <sub>out</sub>	0 V	0 V <sub>out</sub>					
	Cable <sup>1)</sup>	M12 connector, 4-pin	Core color:	BN	WH	BU	BK					
		Pin:	1	2	3	4						
<b>Analog sensor</b> <b>redundant</b> <b>R22</b> (2 x 0 ... 10 V DC) <b>R44</b> (2 x 0.5 ... 4.5 V) <b>R55</b> (2 x 0 ... 5 V)			R/U converter 1				R/U converter 2					
			Signal:	+V <sub>1</sub>	U <sub>out 1</sub>	0 V <sub>1</sub>	0 V <sub>out 1</sub>	+V <sub>2</sub>	U <sub>out 2</sub>	0 V <sub>2</sub>	0 V <sub>out 2</sub>	
	Cable <sup>1)</sup>	M12 connector, 8-pin	Core color:	WH	BN	GN	YE	GY	PK	BU	RD	
		Pin:	1	2	3	4	5	6	7	8		

<b>Analog sensor</b> <b>A33</b> (potentiometer 1 kΩ)			Potentiometer									
			Signal:	+V	Out	0 V	n.c.					
	Cable <sup>1)</sup>	M12 connector, 4-pin	Core color:	BN	WH	BU	BK					
		Pin:	1	2	3	4						
<b>Analog sensor</b> <b>redundant</b> <b>R33</b> (2 x potentiometer 1 kΩ)			Potentiometer 1				Potentiometer 2					
			Core color:	+V <sub>1</sub>	Out <sub>1</sub>	0 V <sub>1</sub>	n.c.	+V <sub>2</sub>	Out <sub>2</sub>	0 V <sub>2</sub>	n.c.	
	Cable <sup>1)</sup>	M12 connector, 8-pin	Core color:	WH	BN	GN	YE	GY	PK	BU	RD	
		Pin:	1	2	3	4	5	6	7	8		

<b>Digital sensor</b> <b>CC1</b> (CANopen)			CANopen									
			Signal:	+V	0 V	CAN_GND	CAN_H	CAN_L				
	Cable <sup>1)</sup>	M12 connector, 5-pin	Core color:	WH	BU	BN	BK	GY				
		Pin:	2	3	1	4	5					
<b>Digital sensor</b> <b>redundant</b> <b>RC1</b> (2 x CANopen)			CANopen 1 + CANopen 2									
			Core color:	+V	0 V	CAN_GND	CAN_H	CAN_L				
	Cable <sup>1)</sup>	M12 connector, 5-pin	Core color:	WH	BU	BN	BK	GY				
		Pin:	2	3	1	4	5					

### Top view of mating side, male contact base

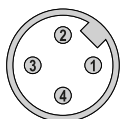

M12 connector, 4-pin

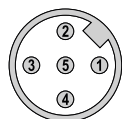

M12 connector, 5-pin



M12 connector, 8-pin

1) Isolate unused cores individually before initial start-up.

### Technology in detail

#### Operating principle

##### Construction

The core of a draw-wire device is a drum mounted on bearings, onto which a wire is wound. Winding takes place via a spring-loaded device. A specific feature of Kübler draw-wire mechanics is the single-layer wire winding (for short wire lengths) to ensure best possible linearity.

Depending on the required linearity, a multi-layer winding may however be accepted for the C60 draw-wire encoder.

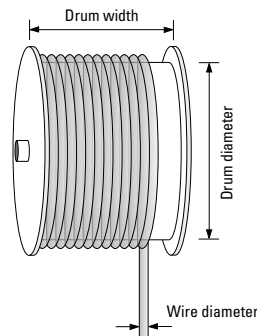

##### Note

Exceeding the maximum extension length of the draw-wire will lead to damage to the wire and the mechanics.

In addition, snapping of the cable during installation must imperatively be avoided, as this can also lead to damages.

#### Wire fastenings

Carabiner ring  
D8.C60...xxxx.xxx.xxx

M4 thread  
D8.C60...xxxx.xxx.xxx.V001

Eyelet  
D8.C60...xxxx.xxx.xxx.V002

Clip  
D8.C60...xxxx.xxx.xxx.V007



ball-bearing swivel  
(no torsion of the measuring wire during installation)

rubber stopper

measuring wire

#### Wire types

- Stainless steel V4A, plastic coated,  $\varnothing$  0.5 mm, order option **b** = 1
- Stainless steel V4A, plastic coated,  $\varnothing$  0.7 mm, order option **b** = 2
- Stainless steel V4A, plastic coated,  $\varnothing$  1.0 mm, order option **b** = 3

Ideally suited for long-term outdoor use.  
The plastic coating has a dirt-repellent effect and has in the same time optimum sliding properties.



#### Extension wire

For optimum use of the measuring range by extending the wire length, e. g. to allow realizing a pre-extension in the application.

Especially combined with analog interfaces (options A11 ... A55 and R11 ... R55).

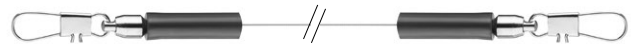

**Draw-wire encoder C60**     **Robust-Line**     **Measuring length max. 4 m**

**Technology in detail**

**Application-specific installation possibilities**

guide pulley

guide pulley

**Extended temperature range -40 °C ... +85 °C**  
 (only in combination with the standard linearity 0.5 %, **C** = 1)

By using special components.  
 Order code extensions for the extended temperature range:

With carabiner ring:	D8.C60.xxxx.xxxx.xxxx.V003
With M4 thread:	D8.C60.xxxx.xxxx.xxxx.V004
With eyelet:	D8.C60.xxxx.xxxx.xxxx.V005
With clip:	D8.C60.xxxx.xxxx.xxxx.V008

**Housing types** (the suitable housing type for every application)

Open housing,  
 order option **U** = 1

Housing with perforated plate cover,  
 order option **U** = 3

Closed housing,  
 order option **U** = 6

# Linear measuring technology

## Draw-wire encoder C60

## Robust-Line

## Measuring length max. 4 m

### Dimensions

Dimensions in mm [inch]

#### With standard linearity (without wire guide)

order option **C** = 1

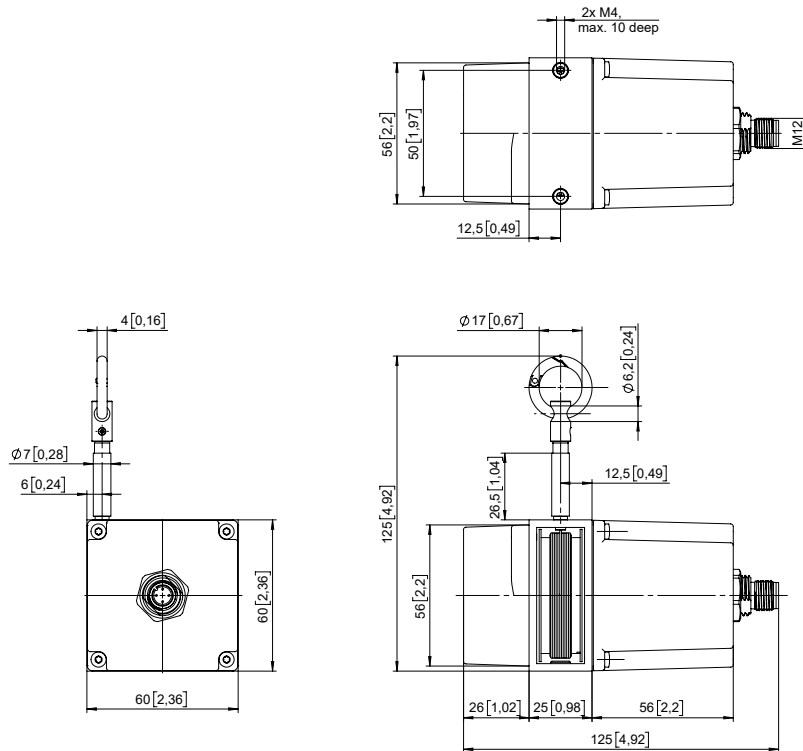

#### With improved linearity (with wire guide)

order option **C** = 2, 3

