

		Page
<b>Basics</b>	Introduction	20
	Selection criteria	21
	Mounting options	22
	Electromechanical counters	23
	Electronic counters	28
	Process displays	36
	Interfaces	43
	Software	44

---

### Counters / Process devices

#### Counting technology

Electromechanical counters in many versions, as well as miniature counters for PCB-mounting (our special area of competence), are ideal time and pulse counters for pumps, lifts, dryers, UV lamps, KWh meters and much more.

The Codix series offers functional, low-cost electronic display counters, position displays, timers and tachometers. Our electronic multifunction preset counters enable decentralised control and so reduce cycle times.

#### Process technology

The user-friendly, compact and functionally well thought through Codix process displays and controllers are ideal for all linear and non-linear analogue signals.

Together with our temperature displays and controllers, as well as our strain-gauge controllers and setpoint adjuster, they are used in a wide variety of applications.

### Application examples

Roller shutter door with automatic shut-off

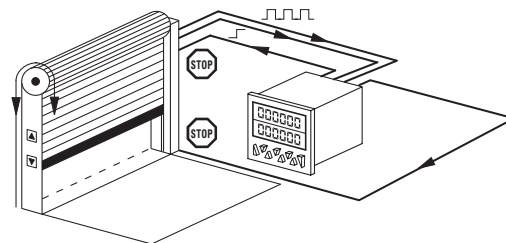

Interval measurement

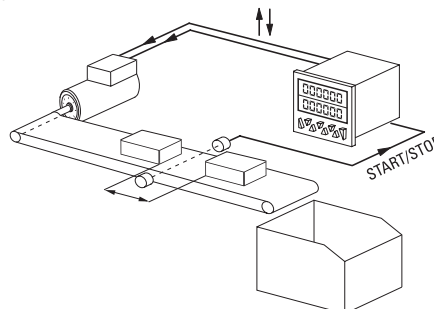

Time-controlled production line

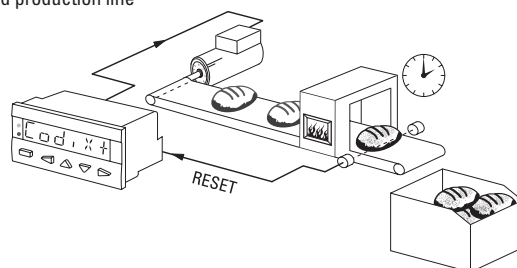



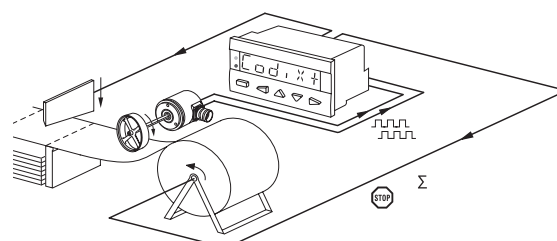

Cut-to-length with overall total count and control of the machine



Counters / Process devices	Selection criteria	
----------------------------	--------------------	--

<b>Conformity</b>	All counters and process devices carry the CE mark and are tested for electromagnetic compatibility and immunity to interference.	The counters and process devices meet the requirements according to EN 61000-6-2, EN 61000-6-4, EN 61000-6-3 and EN 55011 (For details see the data sheets).
-------------------	---	--

<b>Safety</b>	Designed to EN 61010 part 1 Protection class 2 Application area pollution level 2	
---------------	---	--

<b>Approvals</b>	<p>Many of our products are UL (Underwriters Laboratories Inc.) approved.</p> <p>Codix 717 multifunction counter in Ex proof version acc. to explosion-proof class EEX D IIC T6.</p> <p>Kübler is active worldwide and has made a company commitment to protecting the environment. Our product range is RoHS compliant.</p>	   
------------------	--	---

<b>Special versions / Options</b>	These are modifications of standard versions.	The most common versions available are listed under the various type series (further options on request).
-----------------------------------	---	---

<b>Temperature</b>	<p><i>Working temperature:</i> Temperature range of the environment, in which the device complies with the specifications shown in the data sheet.</p>	<p><i>Operating temperature:</i> Temperature range of the environment, in which the device can be operated, without suffering damage.</p>
--------------------	--	---

<b>Soiling and humidity</b>	The IP classification according to EN 60529 describes how the encoder is protected against particles and water. It is described as an abbreviation "IP" followed by two numbers.	The tables show an overview of the common types of IP protection.
-----------------------------	--	---

**Protection against particles**  
(first digit)

The higher the number, the smaller the particles.

<b>0</b>	Not protected
<b>1</b>	Protected against particles $\varnothing$ 50 mm and larger
<b>2</b>	Protected against particles $\varnothing$ 12.5 mm and larger
<b>3</b>	Protected against particles $\varnothing$ 2.5 mm and larger
<b>4</b>	Protected against particles $\varnothing$ 1.0 mm and larger
<b>5</b>	Protected against dust
<b>6</b>	Dust proof

**Protection against water**  
(second digit)

The higher the number, the higher the water pressure can be.

<b>0</b>	Not protected
<b>1</b>	Protected against vertically falling drops of water
<b>2</b>	Protected against vertically falling drops of water when enclosure is tilted up to 15°
<b>3</b>	Protected against spraying water
<b>4</b>	Protected against splashing water
<b>5</b>	Protected against water jets
<b>6</b>	Protected against powerful water jets
<b>7</b>	Protected against the effects of temporary immersion in water
<b>8</b>	Protected against the effects of continuous immersion in water

**Kübler devices are available with a protection level up to IP66.**

Counters / Process devices	Mounting options
----------------------------	------------------

### Panel mount

- Mounting in front panel cut-outs, control cabinet doors, housings etc.
- Display on the front side
- Various mounting options by means of a variety of front bezel adapters
- Gaskets for increased protection levels available as accessories
- Panel mounting offers protection of the connections

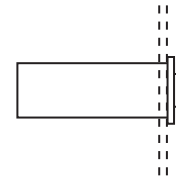

### Base mount

- Fixing onto the mounting plate
- Display on the front side
- High mechanical strength
- Connections above the mounting plate

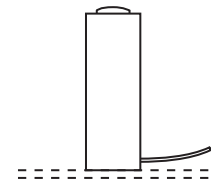

### DIN-rail mounting

- Snap-on mounting on DIN-rail for counters with integrated DIN-rail fixing
- Panel mount counters can be mounted via DIN-rail adapter, plug-in counters via DIN-rail socket
- Display on the front side

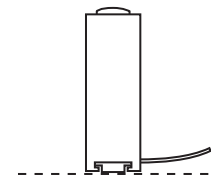

### PCB mounting

- Fixing via solder pins direct onto the PCB board, upright or lying
- Flexible location of the display
- Washable versions with high protection level
- High temperature ranges – also suitable for machine soldering

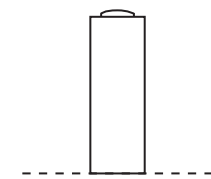
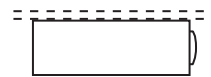

## Electromechanical counters Versions

### Overview

Electromechanical counters are divided into:

- **Pulse counters**
- **Preset counters**
- **Hour meters / Timers**
- **Time preset counters**

The counter construction consists of an electromagnetic drive and a mechanical number wheel system. Electrical impulses cause a step-by-step advance of the number wheels.

Totalising counters add the incoming pulses. They are manufactured without reset, with reset key (button) or with electrical reset. Smaller design counters are also available for battery operation with a low power consumption of 30 or 50 mW, and offer high shock and vibration resistance.

### Pulse counters

These counters have no outputs activated at a specific count value. They are used purely to monitor the count value.

The function of the counters lies primarily in simple totalising of the incoming pulses.

Example:



K 47

W 15

### Preset counters

The purpose of preset counters is to trigger a signal at a particular count value. In the simplest instance this can mean just shutting down a machine, however it could also be the initialisation of control functions (e.g. cutting material to length, transporting parts etc.).

The outputs are suitable for switching large loads. The actual switching capacity depends on the model (counter) and can be seen in the data sheet. With most contacts a changeover function is available.

Example:



BVa 15

#### Adding

The counter starts from zero and counts up to the programmed preset counts, at which an output signal is triggered. The counter is then reset to zero - this can be programmed to happen automatically. The current count value is always displayed.

#### Subtracting

The counter starts from the preset value or from a separate setpoint and counts down to zero, at which an output signal is triggered. The counter is then reset to the preset value. The value displayed corresponds to the difference between the preset value and the count value.

### Hour meters / Timers

Timers measure the time in the unit of time, for which the device is laid out. With the electromechanical counters this time is displayed in hours with one or two decimal places.

Timing starts when the supply voltage is applied to the timer.

The time base is hours with either 1/10 or 1/100 h resolution (1/100 hours = 36 seconds)

Example:



H 57

H 37

### Time preset counters

Preset timers measure the time in the unit of time, for which the device is laid out. With the electromechanical counters this time is displayed in hours with one or two decimal places.

Timing starts when the supply voltage is applied to the timer.

The respective output is activated, as soon as the preset value is reached.

Example:



HVa 15

Electromechanical counters	Basic technical information	
<b>Current type</b>	Our counters are all constructed for DC voltage. On AC voltages a rectifier is always required.	The maximum permissible voltage fluctuation for DC and AC is generally $\pm 10\%$ of the nominal voltage at maximum count frequencies.
<b>Residual ripple</b>	Is the AC voltage superposed on the DC voltage in % $\frac{U_w}{U_g} \times 100\%$	$U_w$ = Effective value of superposed AC voltage $U_g$ = Arithmetical mean value of DC voltage
<b>Power consumption</b>	Is the power in W or VA that a pulse counter consumes at continuous pulse and rated voltage with unheated coil (20°C).	
<b>Maximum pulse frequency</b>	Is the maximum possible count frequency which the counter in question can consume in permanent operation.	It differs according to counter type and power consumption and is limited by the required pickup- and release times of the counting solenoid.
<b>Minimum pulse on time</b>	Is the period of time which is sufficient for accurate counting, even at permissible $\pm$ variation of operating voltage; the pulse interval can be optionally as long as required.	
<b>Minimum pulse interval</b>	Is the period of time which is sufficient for accurate counting.	Optimal spark quenching is imperative if high count frequency is required.
<b>Pulse ratio</b>	Is the ratio of $\frac{\text{pulse on time}}{\text{pulse interval}}$ at maximum count frequency	
<b>On time ED</b>	<p>States how long a coil may be energized without overheating.</p> <p>For the on time the following formula applies:</p> $\text{ED \%} = \frac{\text{pulse on time}}{\text{pulse on time} + \text{pulse interval}} \times 100$ <p>From this can be derived:</p> $\text{pulse on time} = \frac{\text{ED \%}}{100 - \text{ED \%}} \times \text{pulse interval}$ $\text{pulse interval} = \frac{100 - \text{ED \%}}{\text{ED \%}} \times \text{pulse on time}$ <p><i>Example:</i></p> <p>A count coil has the listed value ED = 15 %, max. 55 sec. This coil may therefore remain under constant current for max. 55 sec. After this a cooling interval of</p> $\text{pulse interval} = \frac{100 - 15}{15} \times 55 \text{ sec} = 283 \text{ sec}$ <p><i>Result:</i></p> <p>Since the on time does not exceed 15 % these pulse-on times are permissible.</p>	<p>In addition to the ED % figure the listed values include an addition concerning the maximum permanent on time. Therefore a coil may only be energized by a constant current during this period and then has to be cooled off again.</p> <p>At ED = 100% a limitation is not necessary as the coil will never become inadmissibly hot, even if continuously energized.</p> <p>The same coil is constantly receiving pulses of 40 sec. duration with a count interval of 6 min. Is this still permissible?</p> $\text{ED \%} = \frac{40}{40 + 360} \times 100 = 10\%$
<b>Operating temperature</b>	Is the permissible temperature within the direct vicinity of the pulse counter.	When using the counters in groups, the reciprocal heating must be taken into consideration as this results in an operating temperature rise. The upper or lower value is only applicable to the rated voltage.

## Electromechanical counters Basic technical information

### Instructions for electromechanical pulse counters

DC voltage pulses without or with very small residual ripple are, for example, taken from a battery, DC generator, electronically stabilised power supply, according to the circuit above. These pulses are most suitable for the maximum possible frequencies due to their ideal square wave shape. If only AC voltage is available it must be rectified. Therefore, according to count speed, a more or less greater degree of residual ripple has to be put up with. A simple bridge-rectifier will give a residual ripple of approx. 48%, and the following relationship is applicable:

#### Pulse voltage

AC voltage (effective value)

12 24 48 60 110 220 V

DC voltage (arithm. mean value)

8.5 19.5 40 49 91 185 V

Pulse voltages (at count coil)

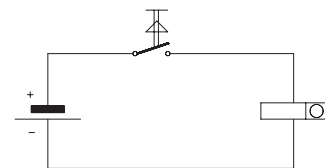
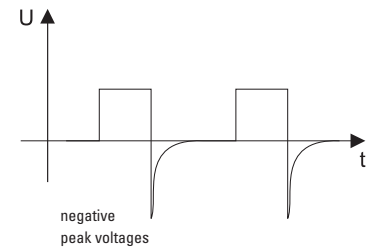

### Two types of switching circuits can be used to drive the counters

#### a) Pulse contact in AC circuit model a0 or a

This circuit is mostly used when the count speed is  $\leq 18$  Hz

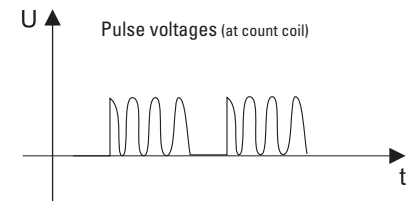
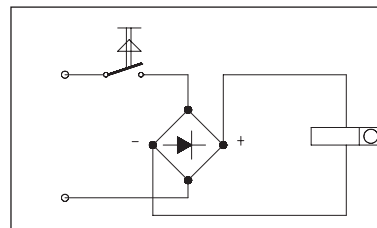

#### Advantage:

No spark required; contact bounces have no negative effect because the rectifier acts as spark quenching and provides inductive drop-out time lag.

#### Disadvantages:

Count speed only possible up to max. 18 Hz

#### b) Pulse contact in DC circuit model 05, 0, 1

With high pulse speeds smoothed DC must be used. The residual ripple (smoothing degree) is determined by the count speed and is stated in the technical specification.

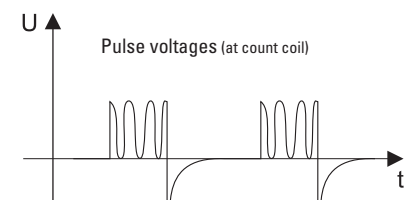
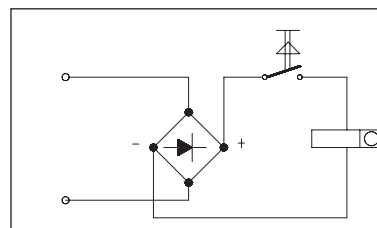

#### Advantages:

High count speed up to max. 25 Hz.  
Only one rectifier is necessary when driving several counters.

#### Disadvantages:

More sensitive to contact bounce, spark quenching is required. 4 connection points required if rectifier is built into counter.

Simple bridge circuit smoothing by capacitor:

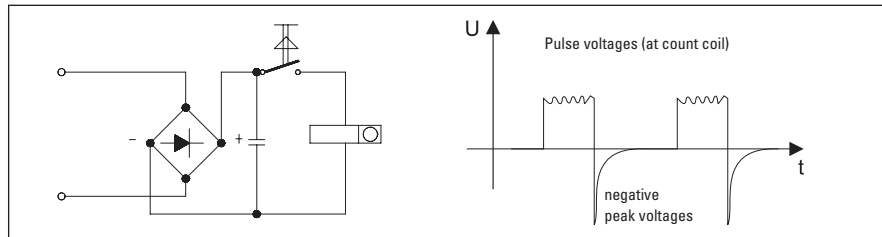

3 phase AC bridge circuit, capacitor not required, residual ripple 4.2 %:

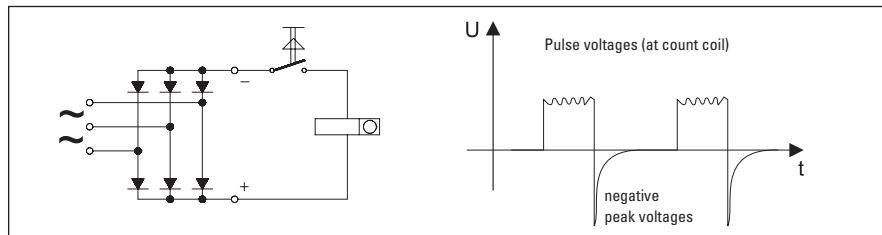

If the rectifiers are connected directly to AC mains, they can often become damaged due to 'contamination' from voltage spikes. These peak voltages are caused by the switching of transformers, spot welding machines, switching motors on and off etc; they often exceed the mains voltage by many times. Therefore it is essential to use a heavy duty rectifier or one with suppressor circuit, so that these peak voltages will not have any destructive effects in the long run.

This is particularly important in the case of silicon rectifiers which are very sensitive to short period excess voltages. It is advisable to use controlled avalanche silicon rectifiers for this purpose.

Rectifiers which we build in or attach to our pulse counters have to a large extent, a high dielectric strength, and an over voltage protection is provided, if required.

### Pulse generators

Appropriate pulse generators are required in order to achieve accurate count results. In this connection, it should be ensured that these operate as far as possible without bounce; this is particularly important for counters with high pulse rate. Cam operated spring contacts, limit switches and micro switches are suitable for count speeds up to

10 or 25 Hz, small relay contacts up to approx. 40 Hz, higher count speed up to 60 Hz can be achieved with reed switches, exact matching of spark quenching being necessary to avoid premature sticking of contact reeds. Even higher speeds can be obtained by using photoelectric or inductive sensors.

### Electrical reset

Counters with electrical reset have an electromagnet which is operated by a reset pulse, and resets the number wheels back to the starting number. With remote reset via a pulse, the pulse duration must be long enough for the reset operation to be completed and for the minimum pulse duration to be maintained in accordance with the technical data of the counters. It is essential that during resetting no pulses may pass into the count mechanism, as otherwise intermediate positions of the number wheel or slippage of the drive mechanism can occur.

There is no danger of mechanical damage of the counter, however.

In order to avoid mistakes, the count pulses should only be allowed to enter, when the number wheels have been accurately adjusted and the drive mechanism is fully engaged. With remote reset a count interval of at least 50 msec after pulse end is required and thus the total count interval = reset pulse time + 50 msec.

### Spark quenching

If the pulse contact is within the DC circuit of the counter, spark quenching is necessary in order to avoid any contact disturbance from the inductive breaking voltage.

Unfortunately, however, a more or less strong dropout delay is produced by the spark quenching and it should be checked in any case whether this will cause disturbance.

### Spark quenching with RC element

This spark quenching produces practically no disturbing dropout delay and is, therefore most suitable for all count speeds. It should preferably be used at very high count speeds.

In general the RC element is located in parallel with the contact in order to produce high frequency interference suppression at the same time. However, it can also be connected in parallel with the coil.

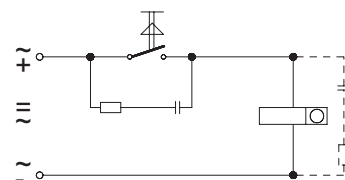



## Electromechanical counters Basic technical information

### Spark quenching with diodes

Considerable dropout delay, therefore only suitable for low count speeds up to 10 Hz. Particular attention should be paid to the correct polarity on connecting.  
The small fitting size is an advantage: e.g. this type of spark quenching can be used for resetting coils.

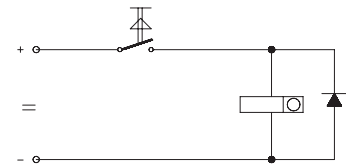

### Spark quenching with zener diodes

Low dropout delay, therefore suitable for higher count speeds because the diode only passes the inductive breaking current when the zener voltage is achieved. It is also suitable for the protection of transistor circuits, where correct polarity must be observed.

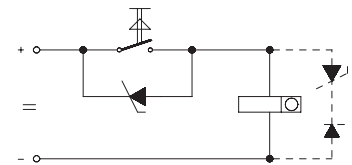

### Spark quenching with varistors

Varistors are voltage dependent resistors whose resistance decreases inertialessly and exponentially with rising voltage. They are therefore, suitable for spark quenching, the varistor ideally being connected in parallel with the coil. It is rated for the current to be approx. 1/10 of the coil current at nominal voltage.

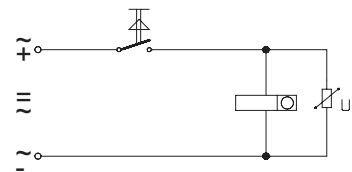

### Identification of counter models

The design of the pulse counters is identified according to type series, version of front panel, and reset, according to the following system:

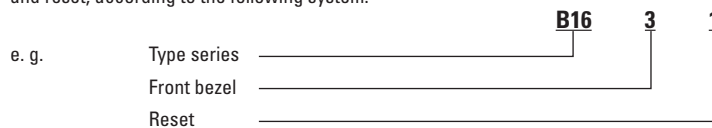

### Electromechanical standard ranges

Please refer to the technical data for the various counters

#### Front bezel

- 0** = no front bezel
- 1** = front bezel for panel with 2 mounting holes
- 2** = front bezel with mounting clip
- 3** = large front bezel for panel with 2 mounting holes

#### Reset

- 0** = without reset
- 1** = manual
- 2** = electrical
- 3** = manual and electrical

For further codes, please refer to the respective counters.

### Versions with coil

Max. possible frequency depends on the type of coil used:

Coil type	max. frequency
05	8 Hz at DC
0	10 Hz at DC
1	25 Hz at DC
a0	10 Hz at AC
a	18 Hz at AC

### General instructions

Selecting the right count frequency is important in order to achieve optimal service life.  
If a counter is only required to operate at a maximum of 10 Hz, then one for 25 Hz should not be used. This is primarily because of the higher service life of the 10 Hz version compared to the 25 Hz model. In addition the 10 Hz counter has a higher duty cycle and a lower power consumption than the one for 25 Hz.

The choice of spark quenching is also very important, particularly at high count speeds (refer to section on spark quenching).  
RC element, silicon diodes and some varistors can be obtained from us.

Certain counter types are supplied with a built in spark quenching. The explanations given in the above paragraphs and the technical specifications of each counter should be noted carefully.

## Electronic counters Versions

### Overview

Electronic counters can be divided into:

- **Pulse counters**
- **Preset counters**
- **Hour meters / Timers**
- **Time preset counters**
- **Tachometers**
- **Position displays**

### Pulse counters

These counters have no outputs activated at a specific count value. They are used purely to monitor the count value.

The functions range from simple totalizing up to position display (with phase discriminator/quadrature). Depending on the speed of the events being counted, the count speed can go up to 100 kHz.

More recent counters have a scale factor, which for example could be used to convert a length measured in inches into meters.

Example:



Codix 130



Codix 520

### Preset counters

The purpose of preset counters is to trigger a signal at a particular count value. In the simplest instance this can mean just shutting down a machine, however it could also be the initialisation of control functions (e.g. cutting material to length, transporting parts etc.).

Relays, transistors or optocouplers are used as outputs. Relays are suitable for switching heavy loads (up to 2000 VA).

The actual switching capacity depends on the model (counter) and can be seen in the data sheet. Most relays are available with a changeover function.

Example:



Codix 560



572



Codix 717 (also Ex)



Codix 923 / 924

#### Adding

The counter starts from zero and counts up to the programmed preset value, at which an output signal is triggered. The counter is then reset to zero - this can be programmed to happen automatically. The current count value is always displayed.

#### Subtracting

The counter starts from the preset value or from a separate setpoint and counts down to zero, at which an output signal is triggered. The counter is then reset to the preset value. The value displayed corresponds to the difference between the preset value and the count value.

### Hour meters / Timers

Timers measure the time in the unit of time, for which the device is laid out. With the electronic meters, the time base is programmable in hours, minutes or seconds or is displayed with two decimal places.

The resolution is determined by the decimal point. Here the smallest possible resolution is milliseconds when operating in the short time meter mode (stop watch function). A time base of hours, minutes and seconds can also be programmed. The time counting starts when the supply voltage is applied to the meter, or is controlled by means of pulses using either the time-interval measuring principle or the pulse width (gate time) principle, with one or two separate inputs.

Example:



Codix 13x



Codix 52U

## Electronic counters Versions

### Time preset counters

Preset timers measure the time in the unit of time, for which the device is laid out (see also timers).  
 With preset timers one, two, four or six outputs, as relay or optocoupler outputs, are additionally available.  
 A particular output is activated, as soon as a pre-selected value is reached. This can occur both in adding or subtracting mode. The signal duration is programmable either as a momentary (timed) pulse or as a maintained (latched) pulse.

Example:



Codix 923 / 924

### Tachometers

Tachometers measure pulses per unit of time, typically pulses per second with frequency measurements or pulses per minute with rotary speed measurement or production quantities and volumes.

Two different measurement principles are used:

- time-interval measurement, where the time between 2 pulses is measured
- gate time (time base), where the number of pulses within a certain time window is measured

The latest models use a mix of both principles, which offers a fast reaction time coupled with the greatest possible accuracy (HRA – High Rate Accuracy System).

Devices with limit values can be used for monitoring rotary speed or rate of production.

Example:



Codix 560



Codix 923 / 924



574

### Position displays

Position displays are devices, which measure pulses from rotary encoders or linear measurement systems, with incremental pulses or absolute position data.

These displayed position values can be scaled using pulse weighting, which means that the display can be converted to any desired magnitude.

Quadrature x1, x2 or x4 input pulse evaluation is available on displays that have incremental inputs.

Type 572 has 2 separate incremental inputs for HTL or TTL signals up to max. 1 MHz. The two values can be mathematically calculated with respect to each other.

Absolute systems are evaluated using the SSI protocol; singleturn as well as multiturn systems can be displayed and evaluated.

The Kübler SSI display has a fast clock frequency up to 1 MHz, suitable for our absolute encoders. It has numerous programmable measurement functions, a freely scalable display and a scalable analogue output; there is also a version with serial interface and a version with 2 limit values.

Example:



571



572



Codix 52x



Codix 54x



Codix 92x



Codix 560

### Display types

Electronic counters are differentiated according to their display type. The most common types of displays used today are liquid-crystal displays (LCD) and light-emitting diodes (LEDs).



#### LCD displays

LCD displays have the advantage of being very economical. They are available in both standard versions and in customised versions.

The advantage of the customised version is that as well as the count value, it is possible to display the preset value and also additional symbols such as, for example, the status of the outputs. With customised models, the height of the digits and the size of the display can be optimally laid out for the corresponding counter.

LCD displays also have the advantage that they are not affected by ambient light and for poorly lit environments they are available with built-in backlighting. Note however that backlit displays do have higher power consumption.



#### LED displays

LED displays are always employed, if units are to be used in environments with diffuse lighting.

Due to their self-luminous display, these models are also easy to read even from a long distance. For each segment, LED displays require a current of between 2 and 10 mA. For a 6-digit counter that could mean from 90 to 450 mA.

As a rule 7-segment displays are the norm, although 14-segment displays or alphanumeric displays can be used to display message texts – as with the Codix 56x multifunction counters and process devices.

### Outputs

We offer our preset counters with various output options:

#### Relays, transistors and optocouplers

Relays should not be used when switching very small loads. Transistor or optocoupler outputs are better suited to operate the input of a controller. The design of both outputs is basically almost the same. However with the optocoupler, galvanic isolation is achieved between the unit (counter) and the peripheral (controller) because of an LED and a phototransistor (in one housing).

As a rule, with the optocoupler output the emitter and the collector are brought out and may have to be switched externally. Using the appropriate circuit it is possible to achieve either negative polarity (normally closed function) or positive polarity (normally open function).

#### Analogue outputs

An analogue output is available with the 57x multifunction devices, dual preset counters as well as with SSI displays.

Your benefits:

- Signal transducer and display with scaling and linearisation in one device
- Additional control of the measured value via 2 relay outputs
- Simple programming
- Transmission of the selected measured value, also over long distances with 4 ... 20 mA signal, to a higher-level controller, PC or a curve tracer
- Output of the current value, totaliser value, MIN or MAX value, programmable as 0 ... 20 mA, 4 ... 20 mA, 0 ... 10 V, 2 ... 10 V analogue signal value

Optocoupler output with negative polarity

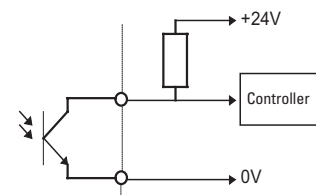

Optocoupler output with positive polarity

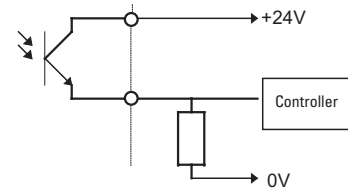

## Electronic counters Basic technical information

### Inputs

The inputs of our counters are designed as transistor inputs. Either NPN or PNP type.

#### Negative input polarity (NPN)

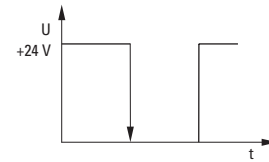
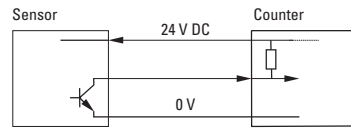

#### Positive input polarity (PNP)

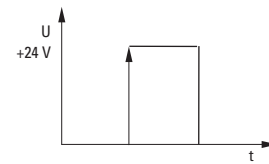
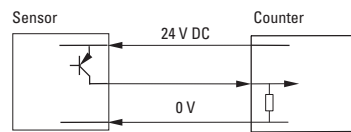

#### High voltage version 10 ... 250 V AC/DC

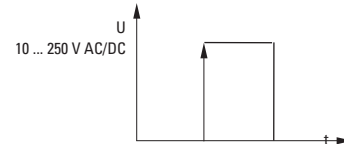
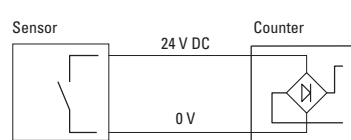

## Electronic counters Input and output modes

### Input modes: pulse counting

Function	Diagram	Note: P: No counting when GATE input is active Preset	PNP: Count on rising edge NPN: Count on falling edge
<b>CNT.DIR</b> Count Direction Mode			Inp A: Count input Inp B: Count direction Add: Display 0 → preset Sub: Display preset → 0
<b>UP.DN</b> Difference Mode			Inp A: Count input add Inp B: Count input sub Add: Display 0 → preset Sub: Display preset → 0
<b>UP.UP</b> Totaliser Mode			Inp A: Count input 1 add Inp B: Count input 2 add Add: Display 0 → preset
<b>QUAD</b> Phase Discriminator / with Quadrature			A 90° B Inp A: Count input – count on rising edge Inp B: Reverse direction Add: Display 0 → preset Sub: Display preset → 0
<b>QUAD2</b> Phase Discriminator with Quadrature and pulse doubling			A 90° B Inp A: Count input – count on rising and on falling edges Inp B: Reverse direction Add: Display 0 → preset Sub: Display preset → 0
<b>QUAD4</b> Phase Discriminator with Quadrature and pulse quadrupling			A 90° B Inp A: Count input – count on rising and on falling edges Inp B: Count input – count on rising and on falling edges, reverse direction Add: Display 0 → preset Sub: Display preset → 0
<b>A / B</b> Ratio			Inp A: Count input 1 Inp B: Count input 2 Formula: A / B
<b>A % B</b> Ratio in percentage			Inp A: Count input 1 Inp B: Count input 2 Formula: (A – B)/A x100

## Electronic counters      Input and output modes

### Input modes: timing

Function	Diagram	Note: P: Preset	PNP: Count on rising edge NPN: Count on falling edge
<b>INA.INB</b> Start – Input A Stop – Input B		No counting when GATE input is active	Inp A: Start Inp B: Stop Add: Display 0 → preset Sub: Display preset → 0
<b>INB.INB</b> Start – Input B Stop – Input B			Inp A: No function Inp B: Start/Stop Add: Display 0 → preset Sub: Display preset → 0
<b>FREE.RN</b> Free Run			Inp A: No function Inp B: No function Control of the timing only via the GATE input  Add: Display 0 → preset Sub: Display preset → 0
<b>AUTO</b> Automatic reset mode			Inp A: No function Inp B: No function Control of the timing only via reset (manual or electrical)  Add: Display 0 → preset Sub: Display preset → 0

Product overview  
Basics

## Electronic counters

## Input and output modes

### Input modes: frequency meters

Function	Diagram	Note: P:	No counting when GATE input is active Preset	PNP: NPN:	Count on rising edge Count on falling edge																					
<b>A</b> Single Mode	<table border="1"> <tr> <td>INP A</td> <td>0</td> <td>F<sub>A0</sub></td> <td>F<sub>A1</sub></td> <td>F<sub>A2</sub></td> <td>0</td> <td>x</td> </tr> <tr> <td>Display</td> <td>0</td> <td>0</td> <td>F<sub>A0</sub></td> <td>F<sub>A1</sub></td> <td>F<sub>A2</sub></td> <td>0</td> </tr> </table>	INP A	0	F <sub>A0</sub>	F <sub>A1</sub>	F <sub>A2</sub>	0	x	Display	0	0	F <sub>A0</sub>	F <sub>A1</sub>	F <sub>A2</sub>	0				Inp A: Frequency input Inp B: No function							
INP A	0	F <sub>A0</sub>	F <sub>A1</sub>	F <sub>A2</sub>	0	x																				
Display	0	0	F <sub>A0</sub>	F <sub>A1</sub>	F <sub>A2</sub>	0																				
<b>A - B</b> Difference Mode	<table border="1"> <tr> <td>INP A</td> <td>0</td> <td>F<sub>A0</sub></td> <td>F<sub>A1</sub></td> <td>F<sub>A2</sub></td> <td>0</td> <td>x</td> </tr> <tr> <td>INP B</td> <td>0</td> <td>0</td> <td>F<sub>B0</sub></td> <td>F<sub>B1</sub></td> <td>F<sub>B2</sub></td> <td>x</td> </tr> <tr> <td>Display</td> <td>0</td> <td>0</td> <td>F<sub>A0</sub></td> <td>F<sub>A0</sub> - F<sub>B0</sub></td> <td>F<sub>A1</sub> - F<sub>B1</sub></td> <td>- F<sub>B2</sub></td> </tr> </table>	INP A	0	F <sub>A0</sub>	F <sub>A1</sub>	F <sub>A2</sub>	0	x	INP B	0	0	F <sub>B0</sub>	F <sub>B1</sub>	F <sub>B2</sub>	x	Display	0	0	F <sub>A0</sub>	F <sub>A0</sub> - F <sub>B0</sub>	F <sub>A1</sub> - F <sub>B1</sub>	- F <sub>B2</sub>				Inp A: Frequency input 1 Inp B: Frequency input 2 Formula: A - B
INP A	0	F <sub>A0</sub>	F <sub>A1</sub>	F <sub>A2</sub>	0	x																				
INP B	0	0	F <sub>B0</sub>	F <sub>B1</sub>	F <sub>B2</sub>	x																				
Display	0	0	F <sub>A0</sub>	F <sub>A0</sub> - F <sub>B0</sub>	F <sub>A1</sub> - F <sub>B1</sub>	- F <sub>B2</sub>																				
<b>A + B</b> Totalising	<table border="1"> <tr> <td>INP A</td> <td>0</td> <td>F<sub>A0</sub></td> <td>F<sub>A1</sub></td> <td>F<sub>A2</sub></td> <td>0</td> <td>x</td> </tr> <tr> <td>INP B</td> <td>0</td> <td>0</td> <td>F<sub>B0</sub></td> <td>F<sub>B1</sub></td> <td>F<sub>B2</sub></td> <td>x</td> </tr> <tr> <td>Display</td> <td>0</td> <td>0</td> <td>F<sub>A0</sub></td> <td>F<sub>A0</sub> + F<sub>B0</sub></td> <td>F<sub>A1</sub> + F<sub>B1</sub></td> <td>F<sub>B2</sub></td> </tr> </table>	INP A	0	F <sub>A0</sub>	F <sub>A1</sub>	F <sub>A2</sub>	0	x	INP B	0	0	F <sub>B0</sub>	F <sub>B1</sub>	F <sub>B2</sub>	x	Display	0	0	F <sub>A0</sub>	F <sub>A0</sub> + F <sub>B0</sub>	F <sub>A1</sub> + F <sub>B1</sub>	F <sub>B2</sub>				Inp A: Frequency input 1 Inp B: Frequency input 2 Formula: A + B
INP A	0	F <sub>A0</sub>	F <sub>A1</sub>	F <sub>A2</sub>	0	x																				
INP B	0	0	F <sub>B0</sub>	F <sub>B1</sub>	F <sub>B2</sub>	x																				
Display	0	0	F <sub>A0</sub>	F <sub>A0</sub> + F <sub>B0</sub>	F <sub>A1</sub> + F <sub>B1</sub>	F <sub>B2</sub>																				
<b>QUAD</b> Frequency with direction	<table border="1"> <tr> <td>Display</td> <td>0</td> <td>0</td> <td>F<sub>A0</sub></td> <td>F<sub>A1</sub></td> <td>F<sub>A2</sub></td> <td>- F<sub>A3</sub></td> <td>- F<sub>A4</sub></td> </tr> </table>	Display	0	0	F <sub>A0</sub>	F <sub>A1</sub>	F <sub>A2</sub>	- F <sub>A3</sub>	- F <sub>A4</sub>			A 90° B	Inp A: Frequency input 1 Inp B: Reverse direction													
Display	0	0	F <sub>A0</sub>	F <sub>A1</sub>	F <sub>A2</sub>	- F <sub>A3</sub>	- F <sub>A4</sub>																			
<b>A / B</b> Ratio	<table border="1"> <tr> <td>INP A</td> <td>0</td> <td>F<sub>A0</sub></td> <td>F<sub>A1</sub></td> <td>0</td> <td>0</td> <td>x</td> </tr> <tr> <td>INP B</td> <td>0</td> <td>0</td> <td>F<sub>B0</sub></td> <td>F<sub>B1</sub></td> <td>F<sub>B2</sub></td> <td>x</td> </tr> <tr> <td>Display</td> <td>0</td> <td>0</td> <td>0</td> <td>F<sub>A0</sub>/F<sub>B0</sub></td> <td>F<sub>A1</sub>/F<sub>B1</sub></td> <td>0</td> </tr> </table>	INP A	0	F <sub>A0</sub>	F <sub>A1</sub>	0	0	x	INP B	0	0	F <sub>B0</sub>	F <sub>B1</sub>	F <sub>B2</sub>	x	Display	0	0	0	F <sub>A0</sub> /F <sub>B0</sub>	F <sub>A1</sub> /F <sub>B1</sub>	0				Inp A: Frequency input 1 Inp B: Frequency input 2 Formula: A / B
INP A	0	F <sub>A0</sub>	F <sub>A1</sub>	0	0	x																				
INP B	0	0	F <sub>B0</sub>	F <sub>B1</sub>	F <sub>B2</sub>	x																				
Display	0	0	0	F <sub>A0</sub> /F <sub>B0</sub>	F <sub>A1</sub> /F <sub>B1</sub>	0																				
<b>A % B</b> Ratio in percentage	<table border="1"> <tr> <td>INP A</td> <td>0</td> <td>F<sub>A0</sub></td> <td>F<sub>A1</sub></td> <td>0</td> <td>0</td> <td>x</td> </tr> <tr> <td>INP B</td> <td>0</td> <td>0</td> <td>F<sub>B0</sub></td> <td>F<sub>B1</sub></td> <td>F<sub>B2</sub></td> <td>x</td> </tr> <tr> <td>Display</td> <td>0</td> <td>0</td> <td>100%</td> <td>F<sub>A0</sub>%F<sub>B0</sub></td> <td>F<sub>A1</sub>%F<sub>B1</sub></td> <td>0</td> </tr> </table>	INP A	0	F <sub>A0</sub>	F <sub>A1</sub>	0	0	x	INP B	0	0	F <sub>B0</sub>	F <sub>B1</sub>	F <sub>B2</sub>	x	Display	0	0	100%	F <sub>A0</sub> %F <sub>B0</sub>	F <sub>A1</sub> %F <sub>B1</sub>	0				Inp A: Frequency input 1 Inp B: Frequency input 2 Formula: (A - B)/A x100
INP A	0	F <sub>A0</sub>	F <sub>A1</sub>	0	0	x																				
INP B	0	0	F <sub>B0</sub>	F <sub>B1</sub>	F <sub>B2</sub>	x																				
Display	0	0	100%	F <sub>A0</sub> %F <sub>B0</sub>	F <sub>A1</sub> %F <sub>B1</sub>	0																				



## Electronic counters      Input and output modes

### Output modes

**Function**      **Diagram**      Only in mode and

**ADD**  
Adding

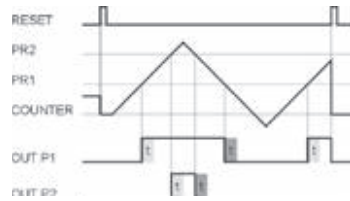

**ADD.AR**  
Adding  
+ Automatic Reset

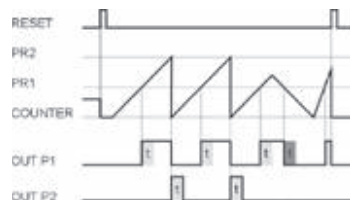

**ADD.BAT**  
Adding  
+ Batch Counter

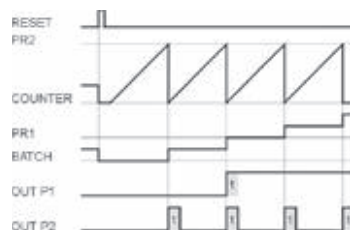

**ADD.TOT**  
Adding  
+ Total Counter

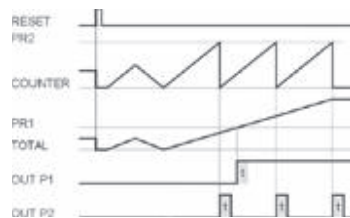

**TRAIL**  
Adding  
Output 1 is Tracking  
Preset of Output 2

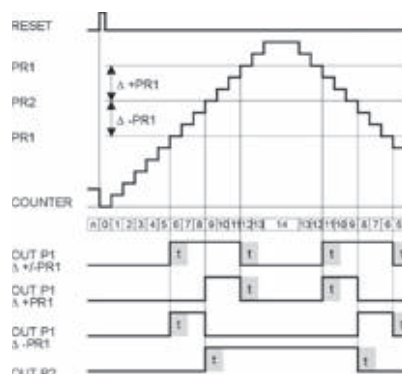

**Function**      **Diagram**      Additionally in mode and

**SUB**  
Subtracting

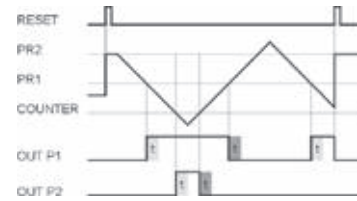

**SUB.AR**  
Subtracting  
+ Automatic Reset

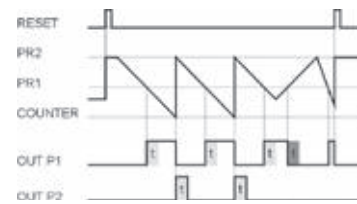

**SUB.BAT**  
Subtracting  
+ Batch Counter

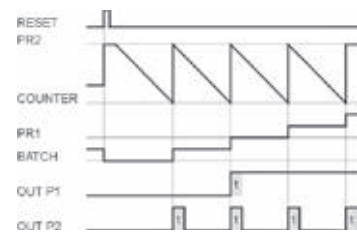

**SUB.TOT**  
Subtracting  
+ Total Counter

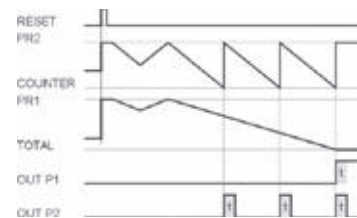

**TR.AR**  
Adding  
+ Automatic Reset  
Output 1 is Tracking  
Preset of Output 2

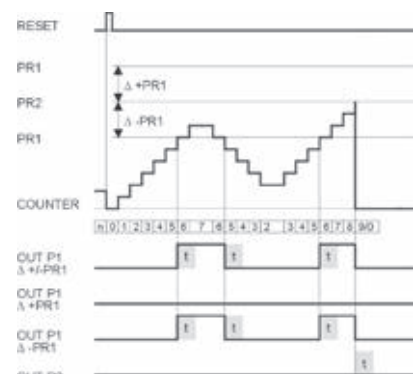

Process devices	Versions
-----------------	----------

## Overview

Process devices are used for

- **Temperature**
  - **Analogue signals**
  - **Strain-gauge**
- or as a
- **Setpoint adjuster**

## Temperature display, Temperature controller

The temperature displays measure temperatures very accurately (by means of inputs from a variety of temperature sensors) and display these in °C or °F using permanently stored characteristic curves.

Furthermore, some devices have an additional freely scalable mV or resistance input, in order to store custom curves and to compensate for sensor inaccuracies. With a resettable MIN/MAX value function, peak values can be precisely measured and retransmitted if required. A variety of thermocouples as well as resistance thermometers (RTDs) in 2, 3 or 4-wire technology can be connected. With running help texts and a quick-start guide, programming is very simple and user-friendly, despite the wide functionality.

The temperature controllers additionally boast 2 limit value alarms, which operate when the measured value exceeds or drops below the limit setpoint, or alternatively within a fixed band.

Thanks to features such as start delay, hysteresis function and averaging, they can be employed in the most diverse applications. They can also be used as simple ON/OFF controllers. The optional analogue output or serial interface enable the retransmission of the measured values to higher-level systems or monitoring devices.

Example:



Codix 531



Codix 564

## Analogue signal displays, Analogue signal controllers

The analogue signal displays measure values very accurately (by means of inputs from a variety of sensors that can be connected) and display these values, freely scalable, in the 5 or 6 digit display.

Furthermore, some devices offer the option to store custom characteristic curves, in order to compensate for sensor inaccuracies. With a resettable MIN/MAX value function, peak values can be precisely measured and retransmitted if required. Sensors with a 0/2 ... 10 V, ±10 V or 0/4 ... 20 mA output can be connected to give precise measuring results. With running help texts and a quick-start guide, programming is very simple and user-friendly, despite the wide functionality.

The analogue signal controllers additionally boast 2 limit value alarms, which operate when the measured value exceeds or drops below the limit setpoint, or alternatively within a fixed band.

Thanks to features such as start delay, hysteresis function and averaging, they can be employed in the most diverse applications. They can also be used as simple ON/OFF controllers. The optional analogue output or serial interface enable the retransmission of the measured values to higher-level systems or monitoring devices. A totaliser function sums the measured value with respect to time, in order to measure quantities or volume over a fixed time period.

Example:



Codix 529



Codix 565

Process devices	Versions
-----------------	----------

## Strain-gauge controller

The strain-gauge controllers measure values very accurately (by means of inputs from a selection of sensors that can be connected) and display these values, freely scalable, in the 6-digit 14-segment display.

These devices offer the option to store custom characteristic curves, in order to compensate for sensor inaccuracies. With a resettable MIN/MAX value function, peak values can be precisely measured and retransmitted if required. A variety of suitable sensors can be connected to the measuring bridge input to give precise measuring results.

With running help texts and a quick-start guide, programming is very simple and user-friendly, despite the wide functionality.

The strain-gauge controllers additionally boast 2 limit value alarms, which operate when the measured value exceeds or drops below the limit setpoint, or alternatively within a fixed band. Thanks to features such as start delay, hysteresis function and averaging, they can be employed in the most diverse applications. They can also be used as simple ON/OFF controllers. The optional analogue output enables the retransmission of the measured values to higher-level systems or monitoring devices. A totaliser function sums the measured value with respect to time, in order to measure quantities or volume over a fixed time period.

Example:



Codix 566

## Setpoint adjuster

The setpoint adjuster is a digital output device for 0 ... 12 V or 0 ... 24 mA analogue signals suitable for plant commissioning or the simulation of sensors.

The current or voltage can be output in 3 modes, either directly, stepped or in a stored time curve (characteristic curve) and is thus ideal also for automatic sequences or approach operations in processes.

Furthermore the display is freely scalable, so that this can be shown in the desired engineering units. Thanks to its small design size and its flexibility, this device will prove indispensable in every workshop.

Example:



Codix 533

# Basics

Process devices	Characteristics
-----------------	-----------------

**Versatile and easy-to-read**

The Codix range of devices from Kübler is the right solution whenever you wish to display and control process values (e.g. standard analogue signals, temperature, pressure) or other analogue measured values, or wish to convert and adapt measured variables.

**Small and compact**

When mounting space is tight, then the Codix 529 to 532 models in their DIN 48 x 24 housing are the ideal solution. When used to display analogue or temperature input signals, the display can be scaled as desired. Furthermore Min/Max values or an overall total value can also be measured.



**Versatile and simple**

If the device is to be operated with gloves, or if it must be legible from a great distance, then the Codix-Series 56X in its DIN 96 x 48 housing is the right choice.

These powerful and very fast displays set new standards when it comes to user friendliness.

Thanks to their easy-to-read 14-segment LED display, easy-to-understand running help texts and a practical quick-start guide, the need to wade through time-consuming full instruction manuals can be eliminated. The guide can be affixed directly to the front of the unit and can be removed and re-applied as required.

With 2 relay outputs and optional analogue output, analogue input signals as well as temperature, pressure or weight can be optimally controlled and monitored.



**Multifunctional**

Multifunction process controller type 573 with analogue output or two limit values.

The process controller with 2 analogue inputs can be used in both single channel mode as well as in dual channel. In dual channel mode, all arithmetic operations are available for displaying the sum total, difference, ratio or the product. Inputs and outputs can be scaled separately.



**Setpoint adjuster**

Setpoint adjuster / time dependent process generator Codix 533.

The setpoint adjuster triggers a standard signal or a freely programmable signal sequence from 0 ... 12 V or from 0 ... 24 mA. The setpoint adjuster is a real innovation, opening up new application possibilities in process technology and automation.



Process devices	Characteristics
-----------------	-----------------

 Product overview  
Basics

**Application areas for process devices**

- |   |  |
|---|--|
| <ul style="list-style-type: none"> <li>• Level measurement</li> <li>• Flow measurement</li> <li>• Silos</li> <li>• Speed display for processing machines</li> <li>• Control cabinet cooling</li> <li>• Woodworking machines</li> <li>• Bakery plants</li> <li>• Drying plants / ovens</li> <li>• Packaging machines</li> <li>• Machine tools and plastic processing machines</li> </ul> | <ul style="list-style-type: none"> <li>• Chemical and pharmaceutical plants</li> <li>• Food and drink machines</li> <li>• Semiconductor industry</li> <li>• Energy supply and climate</li> <li>• Paper machines</li> <li>• Glass production machines</li> <li>• Speed monitoring</li> <li>• Stretch- and compression process monitoring</li> <li>• Monitoring of synchronous operations</li> <li>• Weighing and pressure technology</li> </ul> |
|---|--|

**Application areas for setpoint adjusters**

- |  |   |
|--|---|
| <ul style="list-style-type: none"> <li>• Food, chemical and pharmaceutical plants</li> <li>• Irrigation plants, pump control</li> <li>• Mechanical engineering: for simulating sensors and speed control of motors and pumps, as well as for automatic lubricating of equipment</li> </ul> | <ul style="list-style-type: none"> <li>• Medical technology: for dosing, mixing or simulation</li> <li>• Petrochemicals: for filling, mixing, simulation and for pump control</li> <li>• Laboratory equipment, laboratory working places</li> </ul> |
|--|---|

**Advantages of all process devices**

- |   |   |
|---|---|
| <ul style="list-style-type: none"> <li>• Galvanic isolation</li> <li>• Linearisation function with up to 16 control points</li> <li>• The Codix family concept means simple, unified operation</li> </ul> | <ul style="list-style-type: none"> <li>• Modern industrial design</li> <li>• Short delivery times from stock</li> <li>• Cost-effective price/performance ratio</li> </ul> |
|---|---|

**Advantages of the Codix 533 setpoint adjuster / time-dependent process generator**

- The setpoint adjuster offers three different operating modes:
  - Manual operation
  - Manual ramping operation
  - Automatic ramping operation
- With the automatic ramping operation, the times and setpoint values are programmed and then output automatically.
- With the manual operating modes, the value can either be preset directly or in stepped increments.

Example for automatic ramping operation:

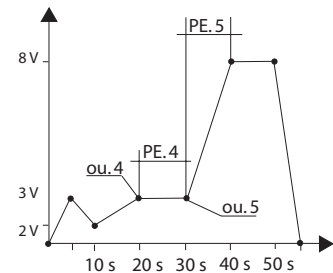
**Analogue output**

Analogue output with Codix 564 temperature controller, Codix 565 process controller for analogue signals, Codix 566 process controller for strain-gauge inputs and type 573 process controller with 2 analogue input signals

Your benefits:

- Signal converter and display with scaling and linearisation in one device
- Additional ON/OFF control of the measured value via 2 relay outputs
- Simple programming via running help texts
- Transmission of the temperature values, pressure values, mV values or resistance values even over long distances, with a 4 ... 20 mA signal to a higher-level controller, PC or curve tracer.
- Output of the current value, totaliser value, MIN or MAX value, programmable as 0 ... 20 mA, 4 ... 20 mA, 0 ... 10 V, 2 ... 10 V value

### Why process devices with an analogue input?

For many measuring operations a digital signal acquisition is too inaccurate or involves too much time and effort. This is why analogue signal acquisition is often used in industrial environments. This includes for example temperature, weight (mass), pressure, filling level, volume (flow), speed, acceleration, position and many others.

The sensor signals are mostly very small (in the mV or  $\mu$ V range). The KÜBLER process controllers amplify these signals, correcting possible errors, and send them to the display.

The signal conditioners Codix 564, 565, 566 convert these signals into analogue signals (e.g. 0 ... 10 V or 4 ... 20 mA). These signals can then be further processed and/or displayed.

The option also exists to transmit the analogue output signals over large distances. Many sensors do not provide a linear output signal. The KÜBLER process displays linearise these signals with up to 16 control points, depending on the model.

### Input signals and output signals

For the input signals, depending on the model, KÜBLER offers the following ranges:

- 0 ... 20 mA
- 4 ... 20 mA
- $\pm 100$  mV,  $\pm 10$  V
- 0 ... 10 V DC
- 2 ... 10 V DC
- 0 ... 500  $\Omega$
- Pt100, Ni100 for 2, 3 and 4-wire technology
- Thermocouples B, E, J, K, N, R, S, T

The 2 ... 10 V and 4 ... 20 mA signals have the advantage that they also offer sensor monitoring at the same time. A 0 V or 0 mA signal may for instance mean that the sensor line is broken.

#### Example:

A digital display with analogue input, e.g. Codix 565, can be used to replace or complement a pressure gauge on a compressor. The current signal of the pressure sensor is displayed as pressure on the display.

Programming of the characteristic curve:

Point 1: 4 mA, 2.5 Pa

Point 2: 20 mA, 30 Pa

Minimum and maximum values are saved and can be called up at any time. The display value can easily be scaled, to show for example atmospheres or bar instead of Pa, by modifying the points of the characteristic curve.

With the Codix 564, 565, 566 and with type 573 KÜBLER offers the following output signal ranges for further processing:

- 0 ... 20 mA, 4 ... 20 mA, 20 ... 4 mA, 20 ... 0 mA
- 0 ... 10 V, 2 ... 10 V, 10 ... 0 V, 10 ... 2 V,  $\pm 10$  V

Optocoupler or relay outputs in conjunction with adjustable limit values.

The 2 ... 10 V, 4 ... 20 mA and und 10 ... 2 V, 20 ... 4 mA signals have the advantage that they also offer sensor monitoring at the same time.

A 0 V or 0 mA signal may for instance mean that the sensor line is broken.

This value can be programmed separately for cases where a fault occurs.

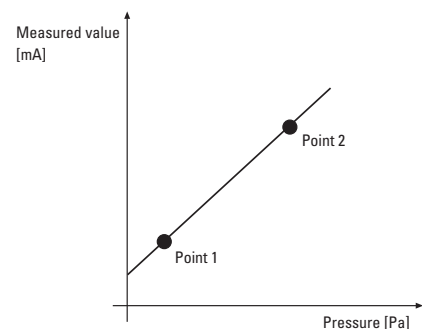

### The function of the totaliser

The devices equipped with the totaliser function (Codix 530, 565, 566) can calculate the integral, that is to say "totalise" the analogue signal, using any period of time (with the Codix 566 this is done by manual totalising).

A typical field of application is flow measurement.

In this case, an analogue sensor measures the flow quantity per time unit in a pipe and displays the momentary flow value (e.g. litres per minute).

From this constantly fluctuating quantity the totaliser calculates a "total", that is to say it defines the absolute quantity that has flowed through the pipe (e.g. in litres).

## Process devices

## Characteristics

### Which temperature display / controller is the right one for you?

The device must be chosen according to the temperature sensor used.

#### Pt and Ni resistance sensors:

Temperature measurement with resistance sensors uses the temperature sensitivity of metal resistances. A constant current is applied to the measuring resistance. The voltage drop at the resistance is measured. This drop represents the temperature measurement.

KÜBLER offers the following devices for resistance sensors:

#### Codix 531, Codix 564

#### Thermocouple sensors:

Temperature measurement with thermocouple sensors uses the thermoelectric effect. Thermocouples consist of two wires, soldered together.

The wires are made of different metals. The thermoelectric voltage appearing at the soldering point is measured, amplified and displayed by the KÜBLER display.

KÜBLER offers the following devices for thermocouple sensors:

#### Codix 532, Codix 564

The Codix 564 display is suitable for resistance sensors as well as for thermocouples.

### Information about 2, 3 or 4 wire circuits

Unlike thermocouples, which deliver a voltage, a resistance does not deliver any signal by itself. This means that it requires external energy from an electrical measuring circuit. This power source is generally a constant current source.

With the 2 wire circuit, the measuring resistance is connected to the measuring device by means of two wires. The conductors are connected serially with the measuring resistance and lead to a higher total resistance, and thus to a measuring error.

With the 3 wire circuit, an additional wire is connected to the resistance, resulting in two measuring circuits. The resistance of the conductors is compensated for by means of internal circuits, provided all three conductors are identical.

With the 4 wire circuit, the resistance of all conductors is compensated for, even if they have different lengths.

### Overview of the temperature measuring range

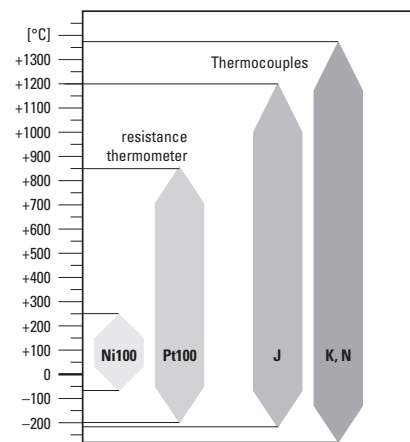

The diagram opposite shows an overview of the temperature range of the various sensors.

Advice:

- for Pt100 resistance sensors adhere to DIN IEC 751
- for Ni100 resistance sensors adhere to DIN 43760
- for thermocouple sensors adhere to DIN IEC 584.
- J: (Fe-CuNi)
- K: (Ni-CrNi)
- N: (NiCrSi-NiSi)

#### J: (Fe-CuNi)

These thermocouples are very common, economic and deliver a high thermoelectric voltage. Disadvantage: danger of corrosion. Iron becomes brittle with sulphurous gases.

#### K: (Ni-CrNi)

These thermocouples are very common, demonstrate excellent long-term stability but only have a low thermoelectric voltage.

#### N: (NiCrSi-NiSi)

These thermocouples are not common, since they appeared only recently on the market. They can be used for very high temperatures and can replace elements out of noble metal.

Process devices	Applications
-----------------	--------------

### Temperature monitoring in a tubular furnace

When the process temperature is higher or lower than the set value, the heating of the oven is directly controlled by means of the relay outputs of the Codix 564 temperature controller.

In case of very high power, the process controller can also drive a power contactor.

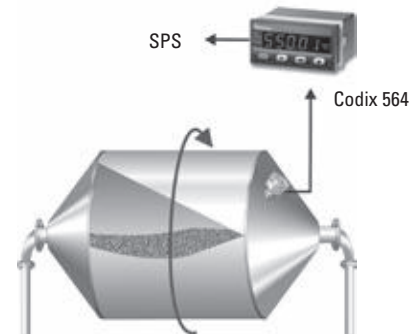

### Linearisation of the characteristic curve of a container

Our process controllers linearise the relationship between the fill-up level  $h$  and the volume  $V$  of the container. This can be set exactly thanks to 12 or 16 control points.

The devices of the Codix 565 or type 573 can output the linearised values as current or as voltage values (e.g. 4 ... 20 mA) and thus offer in addition the function of a voltage transformer.

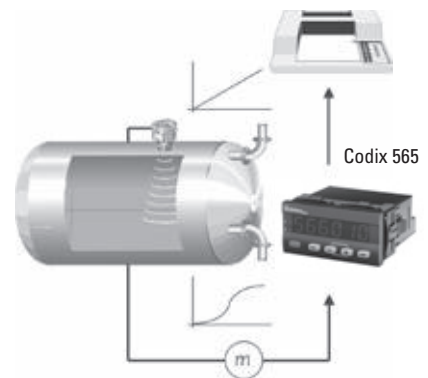

### Control of the heating of a furnace

The furnace temperature is monitored thanks to a temperature sensor. When the temperature becomes higher or lower than a defined temperature, the Codix 564 sends an output signal to the PLC, which controls, among others, the heating of the furnace. The operator can read the temperature on the large LED display.

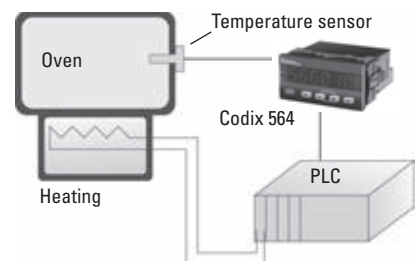

### Measurement of the total throughput [m³] and of the flow [l/min]

Thanks to its double function, the Codix 530 or 565 measures the total throughput in [m³] and the momentary flow in [l/min]. The sensor delivers a current signal proportional to the flow:

0 mA => 0 l/min

20 mA => 1000 l/min.

The total volume is calculated by the integration function (totaliser). Switching of the display is carried out by the front key.

The Codix 565 has two additional limits and an optional analogue output.

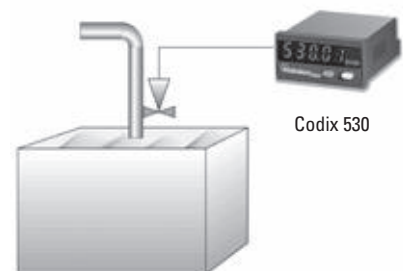

### Weight determination

A strain gauge tape or a strain gauge bridge measures the pressure of the item to be weighed.

The differential signal voltage lies in the mV range and this is converted to the desired weight and displayed by a Codix 566.

Strain gauges with 3.3 – 3.0 – 2.0 – 1.5 and 1.0 mV/N sensitivity can be connected directly to the input of the Codix 566.

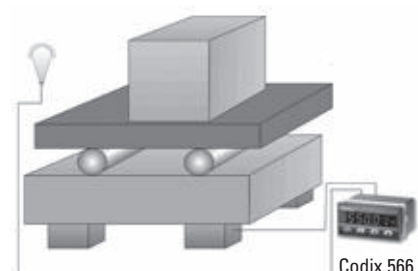



Kübler counters use the following serial interfaces:

- RS232
- RS422
- RS485

### Serial interface RS232

The serial interface RS232 is a full-duplex point-to-point connection.

Full-duplex means that data can be both transmitted and received simultaneously via the interface and that only two devices can be connected with each other. If two devices are to be connected to a computer, then a second interface port is required on the computer. The two connections are totally independent from each other.

This method has a disadvantage, because interface cards for PLCs are expensive and with PCs a maximum of 4 ports are available for use. For this reason, more recent Kübler counters are equipped with either the RS422 or the RS485 interface.



At least a 3-wire cable is needed when connecting RS232. The connection then works without handshaking. For connections with handshaking a 5-wire cable is needed.

### Serial interface RS422

This interface is a full-duplex multi-point connection.

This means that several receivers can be connected to one transmitter cable. In counting technology the PC or the PLC are used as the master station, which then controls all activity on the serial line.

All devices 'listen' to what the master is transmitting, but only that device, which is being addressed, answers. A message can only be sent from one device to another via the master.

Connecting the PC standard RS232 port to the RS422 counter interface is done by means of a simple interface converter. By using this solution, up to 10 devices can be connected to the serial port of a PLC or PC.

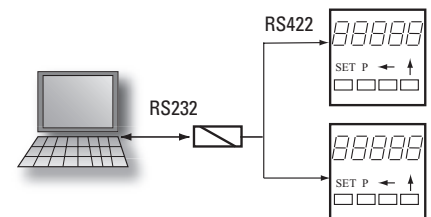

The wiring is done using a 4-wire cable with all the devices being connected in parallel. Each device has to be assigned a unique address, so that it can distinguish between messages being sent to its own address and those for another address.

### Serial interface RS485

This interface is a half-duplex multi-point connection.

Half-duplex means that the data exchange works in both directions, but only in one direction at a time. It also means that one can transmit and receive over the same line. Converting the common RS232 interface to RS485 is not so easily done. However several devices can act as masters as well as also being receivers (slaves).

In total up to 32 devices can be connected to one interface. When connecting the stations together, only a two-wire cable is necessary. Most fieldbuses operate on this interface basis. The hardware is thus always the same, it is only the protocol that differs - this says which device is being addressed, which information is for that device and what control information is required to check that the transmission has been done correctly.

### Interface comparison

Interface	RS232	RS422	RS485
Mode of transmission	asymmetrical with respect to GND	symmetrical without earth connection	
No. of senders	1	1	32
No. of receivers	1	10	32
Transmission distance	15 m [49.2']	1200 m [3937']	1200 m [3937']
Transfer rate	20 kBit/s	10 Mbit/s	10 Mbit/s
Sender output signal without load	+/- 15 Volt	+5 Volt	+5 Volt
Driver load	3.7 kOhm	120 Ohm	60 Ohm

## Software

### Software OS2

- User-friendly programming software for displays 570, 571 and 572 with serial interface
- Upload and download functions
- Monitor and terminal program for simple diagnostics
- Online display of measured values in the monitor program
- Free download from our website

