

		Page
Basics	Encoders Introduction	20
	Encoders Selection criteria	21
	Installing encoders	23
	Incremental Encoders	26
	Absolute Encoders	31
	Encoders for Functional Safety	37
	Linear Measuring Technology	38
	Connection Technology	39

Encoders can be used in applications, where length, positions, speed or an angular position are measured. They transform mechanical movements into electrical signals and can be divided into incremental and absolute measuring systems.

Incremental encoders generate pulses, where the number of pulses can be a measure of speed, length or position.

In absolute encoders, every position corresponds to a unique code pattern, so that even after a power cut the actual position is recognised, when power is re-applied.

In principle we can supply all encoders, whether with a solid shaft or in a hollow shaft version.

Using a hollow shaft encoder saves up to 30 % of costs and up to 50% of the required space compared to a shaft encoder. This is achieved by avoiding additional couplings, brackets and other assembly aids.

To mount a hollow shaft encoder it just needs to be pushed onto the shaft, clamped, and in the simplest case prevented from rotating by using a cylinder pin. Moreover, in principle, hollow shaft encoders require less installation depth.

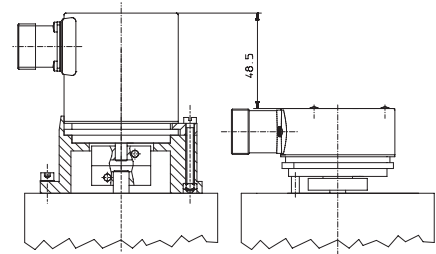

Application examples

Angular measurement

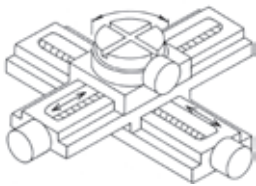

Positioning

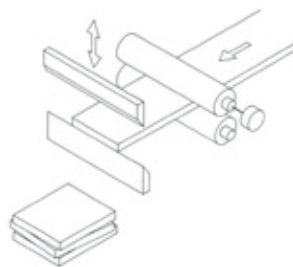

Detecting of fork's position

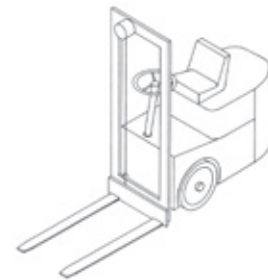

Detecting of position

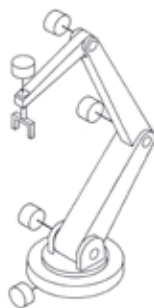

Angular measurement



Velocity measurement, e.g. in drive engineering (geared motors)

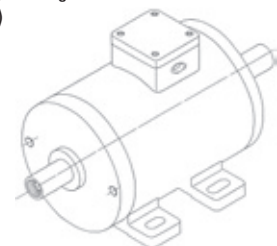

Encoders Selection Criteria

Conformity All Kübler encoders fully comply with the CE-regulations and are intensively tested in our EMC laboratories. They conform to CE requirements according to EN 61 000-6-2, EN 61 000-6-4 and EN 61 000-6-3.

High quality of signals Kübler's encoders excel thanks to electronic temperature and ageing compensation.

Approvals Many of our products are UL (Underwriters Laboratories Inc.) approved. Many of our products can also be supplied on request with EX approval for use in Hazardous Areas Zones 2 and 22. All new plant and equipment that is destined for use in explosion-protected areas must be installed according to Directive 94/9/EG (ATEX 100a). Our products that are approved for use in hazardous areas carry additional labelling in line with RL 94/9/EG and EN 50014.



Kübler is active worldwide and has made a commitment to protecting the environment. Our products comply with the RoHS standards.

Ageing compensation Every LED loses some of its luminosity over time. Without ageing compensation the excellent quality of the output signals would suffer. The phase shift of 90° necessary to detect the direction of rotation would be lost. This effect however is prevented by means of special electronic circuitry.

Benefit: The ageing compensation circuit ensures the same signal, even after many years of operating time. The downtime of machines will be reduced dramatically and the reliability is increased.

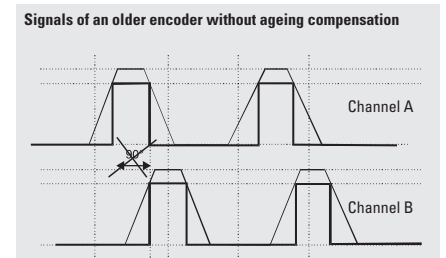
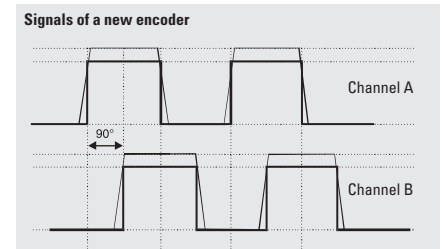

Temperature compensation This circuit ensures that the signal will remain the same over the whole working temperature range. **Benefit:** The positioning accuracy of a machine will not be affected by temperature changes.

Current Consumption The typical values for current consumption given in the catalogue apply for ambient temperature (23°C). Because of the temperature compensation, the current consumption of the encoder rises with the temperature. This increase in current is taken into consideration when giving the figure for maximum current consumption. The output currents are dependent on the user's input circuit and are therefore not included in the figures given; these should therefore be calculated and added in.

Short-circuit Protection The outputs of all the encoders are short-circuit protected, provided that the supply voltage is correctly wired. If an output is connected by mistake to 0 V or +U_B or with another output, the device will not be damaged. As soon as the error is corrected, the encoder is ready for use again. **Benefit:** Wiring circuit errors during installation that often occur in the hectic of day-to-day industrial environments do not lead to the encoder being permanently damaged.

Encoders Selection Criteria

Environmental conditions



The environmental conditions in which the encoder operates can have a significant influence on its service life, for example

- The ambient temperature
- The expected shaft load
- Soiling and humidity
- Noise interference

Thanks especially to the high-quality technology employed in our encoders, they are particularly suitable for use in harsh environments.

Numerous references from our customers, including Bosch, Siemens, Bombardier and from suppliers to the automotive industry, are proof of this.

Temperature

Working temperature:

Is defined as the environmental temperature, in which the encoder will produce the signals defined in the data sheets.

Operating temperature:

Is defined as the environmental temperature, in which the encoder can be operated without incurring damage.

Soiling and humidity

The IP classification according to EN 60529 describes how the encoder is protected against particles and water. It is described as an abbreviation "IP" followed by two numbers.

These two tables summarise the most used IP ratings.

Protection against particles (first digit)

The higher the number the smaller the particles.

0	Not protected
1	protected against particles 50 mm and larger
2	protected against particles 12.5 mm and larger
3	protected against particles 2.5 mm and larger
4	protected against particles 1.0 mm and larger
5	protected against dust
6	dust proof

Protection against water (second digit)

The higher the number, the higher the water pressure can be.

0	Not protected
1	Protected against vertically falling drops of water
2	Protected against vertically falling drops of water when enclosure is tilted up to 15°
3	Protected against spraying water
4	Protected against splashing water
5	Protected against water jets
6	Protected against powerful water jets
7	Protected against the effects of temporary immersion in water
8	Protected against the effects of continuous immersion in water

Our encoders have a protection up to IP 69k.

9K	acc. to DIN 40050 / Part 9: protected against high-pressure water/ steam jet cleaning
-----------	---

Designation of colours to DIN IEC 757

abbreviation	colour
BK	black
BN	brown
RD	red
OG	orange
YE	yellow
GN	green
BU	blue
VT	violet
GY	grey
WH	white
PK	pink
GD	gold
TQ	turquoise
SR	silver

Encoders Installing Encoders

Encoders shafts and in turn their bearings are subjected to loads for a variety of reasons:

- Installation tolerances when mounting the encoders (radial and angular displacement)
- Thermal changes, e.g. linear expansion of the drive shaft
- Effects of wear, e.g. radial runout of the drive shaft or vibrations

These load factors have a direct effect on the life expectancy of the shaft bearings and on the quality of the signal.

Facilities must therefore be provided during installation to compensate for these forces. For encoders having a solid shaft this is generally done by using shaft couplings between the drive shaft and the encoder shaft. The solution with hollow shaft encoders is to use stator couplings, fixing brackets or torque stops between the encoder flange and the mounting surface.

Not making use of a coupling but instead rigidly mounting the shaft and the encoder housing generally leads to unacceptably high loads on the bearings; the ensuing wear will cause the encoder to fail prematurely.

In order to avoid permanent damage of the encoder, certain bearing loads should not be exceeded. If hollow shaft encoders are correctly installed and the torque stops or stator couplings that are available from Kübler are used, then no problems should occur. For solid shaft encoders the maximum permitted axial and radial loads are shown in the appropriate technical data.

Safety-Lock™ – Safety-Lockplus™



Safety-Lock™

Interlocked bearings, large bearing span and extra strong outer bearings ensure stability when subjected to vibration and tolerance of installation errors. Machine downtime and repairs are eliminated.

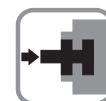

Safety-Lock™

Safety-Lockplus™

The proven Safety-Lock™ construction with additional mechanically protected shaft seal.

Mounting options for hollow shaft encoders

Mounting of a hollow shaft encoder with torque stop and pin (easiest and fastest mounting).

Standard hollow shaft encoders are equipped with the torque stop. (Cylindrical pin not supplied.)

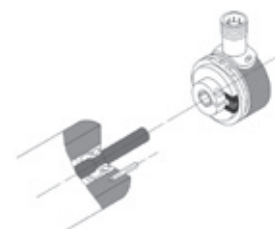

Mounting of a hollow shaft encoder with extended torque stop and long pin.

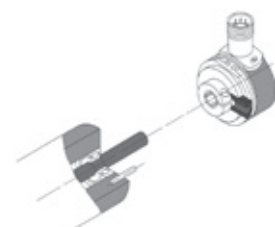

Mounting of a hollow shaft encoder with a stator coupling.

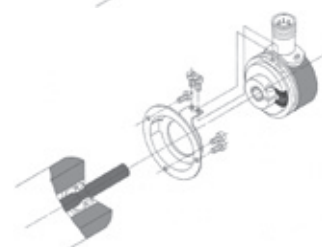

Mounting examples for shaft encoders with synchronous flange

Mounting with fastening eccentrics and coupling (to reduce shaft overload).

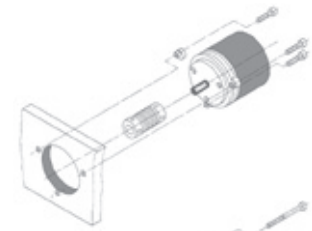

Mounting with assembly bell, fastening eccentrics and coupling (to prevent shaft overload and to isolate the encoder thermally and electrically).

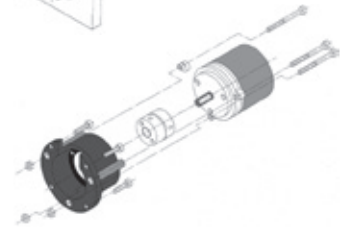

Mounting examples for shaft encoders with clamping bracket

Mounting with an angular bracket and coupling (to reduce shaft overload).

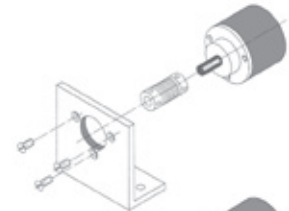

Mounting with a commonly used clamping device and coupling (to reduce shaft overload).

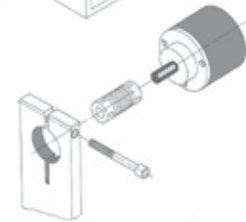

Loading of encoder shaft bearings using coupling forces

With all spring couplings (shaft coupling, stator coupling, fixing bracket), alignment and axial errors are converted to a force that corresponds to the spring constant of the coupling.

This force has to be absorbed by the encoder shaft bearings. When installing an encoder, this should be done with as little force as possible, i.e. without any unnecessary initial tension on the coupling. If this is adhered to, then with all Kübler couplings adequate tolerance compensation is guaranteed for the whole service life of the encoder bearings.

This force does not occur with torque stops for hollow shaft encoders, where the encoder is prevented from turning also by means of a pin or rod.

Although the encoder is prevented from rotating due to a rigid interlock, the encoder is still free to move in any other direction. This is of course dependent on it being mounted in such a way that it has freedom to move radially and especially axially (thermal linear expansion of the drive shaft!).

Possible errors in accuracy due to couplings

1. Deviations in accuracy caused by torsion of a spring coupling (in particular shaft couplings)

This deviation in accuracy is defined by the torque to be transmitted (bearing friction and mass moment of inertia) and by the torsional spring constant of the torque stop.

The following applies:

$$\text{Max. error (degree)} = \frac{\text{max. torque [Ncm]}}{\text{torsional spring constant [Ncm/Grad]}}$$

The following table serves to estimate the ratio between such an error and the smallest increment of an encoder:

Relationship between the resolution of an encoder in bit and the smallest increment in angular degrees:

Resolution	binary	10 bit	11 bit	12 bit	13 bit	14 bit	17 bit
	ppr	1024	2048	4096	8192	16384	131072
Increment	degrees	0.352	0.176	0.088	0.044	0.022	0.0028
	degrees:min:sec	0:21:06	0:10:33	0:05:16	0:02:38	0:01:19	0:00:10
	sec	1266	633	316	158	79	10

Possible errors in accuracy due to couplings

2. Deviations in accuracy caused by radial play in the drive shaft with asymmetrical mounting of the couplings

Here one has to differentiate between couplings that are mounted in an axially symmetrical manner round the shaft (all shaft couplings, many stator couplings) and asymmetrically mounted couplings (many stator couplings, all mounting brackets and pin-based torque stops).

With asymmetrical couplings deviations in accuracy can arise due to radial movements of the drive shaft (radial runout/play); this is determined by the system. These deviations are dependent on the amount of the radial play and the distance of the torque stop locating point from the drive shaft.

The relationship is shown in the following diagram:

Maximum permissible radial runout to achieve an accuracy >1/2 LSB when using an asymmetrical 1 point torque stop

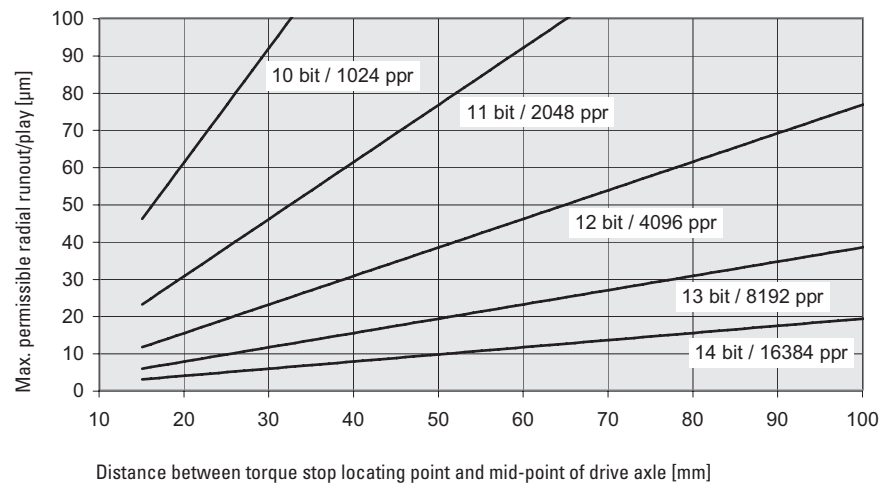

Particular shaft loading due to toothed-wheels, gear-pulleys and similar elements

Measuring wheels, toothed wheels or gear pulleys, which are mounted directly on the encoder shaft, exert radial forces on the latter, dependent on prestressing and angular acceleration.

Kübler encoders are designed so that they can absorb these forces to a great extent. The maximum permissible load capacity of the shaft is shown in the technical data for the encoder.

If these load values may be exceeded in a particular application, then the encoder shaft must be isolated from the radial load by interposing an appropriate shaft with its own bearings that can absorb the forces.

Kübler offers suitable bearing blocks and bearing boxes for this purpose (please refer to the 'Accessories' section in the catalogue).

Assembly and function

Optical scanning

A disc fitted with a grating, having a code pattern of slits and bars, is mounted so that it can rotate between an LED and a receiver.

The light emitted by the LED is modulated by the mask and grating and then strikes the receiver, which produces a signal proportional to the luminosity.

When the disc rotates this signal has a shape that approximates to a sine wave.

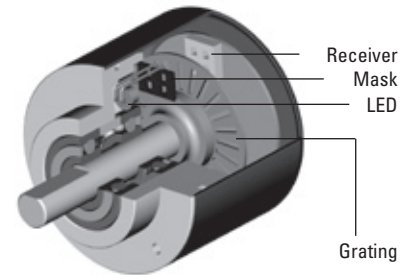

Magnetic Scanning

The magnetic field created by a rotating permanent magnet is scanned by a sensor Asic. Each angular position has underlying field vectors, which are converted by the ASIC into incremental signals.

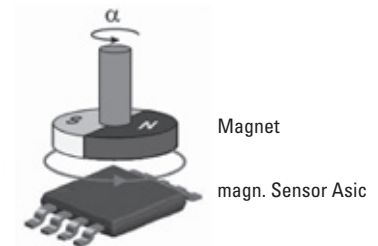

Mechanical advantages of Kübler encoders

- Robust bearing construction: „Safety-Lock™ Design“, Interlocked bearings, large bearing span and extra strong outer bearings ensure stability when subjected to vibration and tolerance of installation errors. Machine downtime and repairs are eliminated.

- Ideal for use outdoors thanks to its solid die-cast housing and radial shaft seal.

The Sendix Incremental benefits from a high IP67 protection rating and a wide operating temperature range from -40°C up to +90°C.



Processing of the signals

The sine wave signals are then processed in a specially designed electronic circuitry. Most controllers require square-wave signals on their input.

The signals are therefore pre-processed accordingly in the encoder and made available using various output circuits depending on the application.

Number of channels

Encoders with one output channel:

Encoders with one output channel are used where no direction sensing is needed, e.g. speed control or length measuring.

Encoders with two output channels:

Applications, where the direction of rotation should be sensed, e.g. positioning, require encoders with two channels A and B being shifted 90° out of phase. By detecting the phase shift, the direction can be determined.

- Shaft turning clockwise, top-view of shaft / for hollow shaft encoders, viewing the flange
 - Inverted signals available
- t_r = rise time
 t_f = fall time

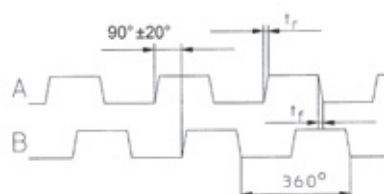

Encoders with three output channels

In addition to the two channels A and B a zero pulse is available, which occurs once per revolution and is usually used for the reference run (zero point calibration) of a machine.

- Shaft turning clockwise, top-view of shaft / for hollow shaft encoders, viewing the flange
 - Inverted signals available
 - 0 pulse is linked to AND with channel A and B
- t_r = rise time
 t_f = fall time

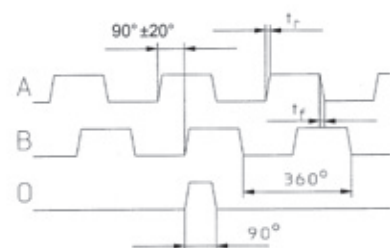

Encoders Incremental Encoders

Multiplication of pulses

The resolution of a two channel encoder can be multiplied by two or four using special edge detection circuitry.

An encoder with physically 5000 pulses per revolution can generate 20000 pulses per revolution using this technique.

Inverted signals

When used in environments, with a lot of electrical noise and/or if very long cable distances are required, we recommend using encoders with inverted (complementary) signals.

These signals are always available with output circuits of the RS422 type and sine wave outputs or optionally with push-pull outputs.

Resolution

The required angular or linear resolution of a application determines the number of pulses per revolution. Linear movements must first be converted into rotary, for example by means of a spindle.

Example:

An encoder is equipped with a measuring wheel. Every revolution corresponds to a distance of 200 mm (circumference). The accuracy should be 0.1 mm. What is the required resolution (ppr)?

- given:
- Circumference of the measuring wheel: $U = 200$ [mm]
 - Accuracy of the system: $G = 0.1$ [mm]
- wanted:
- Resolution of the encoder: $A = ?$ [pulses/resolution]

$$\text{Resolution} = \frac{\text{Circumference}}{\text{Accuracy}} = \frac{U}{G}$$

The required resolution would be 2000 ppr (pulses per revolution).

Pulse frequency

The required pulse frequency can be calculated as a result of the number of pulses per revolution (PPR) and the maximum speed (RPM). The maximum pulse frequency is shown in the data sheet specifications for each encoder.

Generally this is 300 KHz, but can be up to 800 KHz with high-resolution encoders.

Example:

- given:
- Speed $n = 3000$ min^{-1}
 - Resolution of the encoder $R = 1000$ ppr
- wanted:
- Required pulse frequency of the encoder

$$f_{\text{max}} = \frac{n \times A}{60}$$

The required pulse frequency is thus 50 KHz. This can now be compared with the maximum possible pulse frequency of the desired encoder.

This diagram can be used to estimate the required pulse frequency

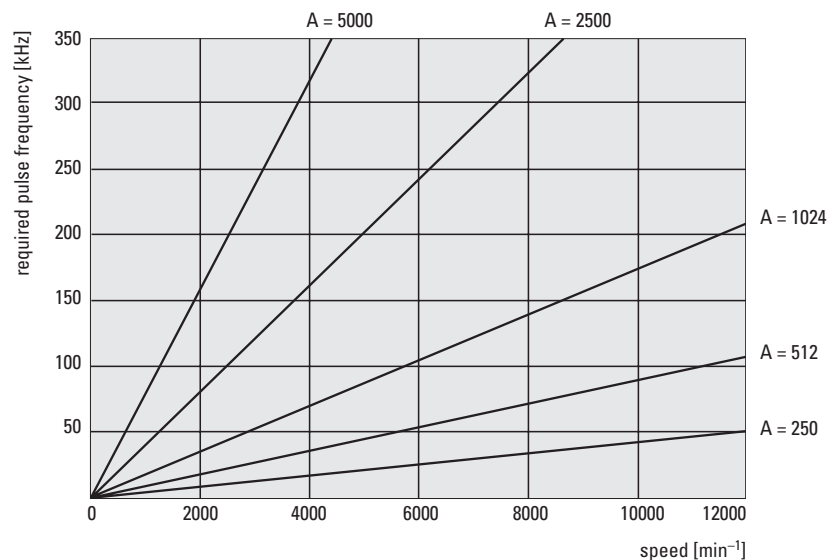

Outputs and voltage supplies (overview)

Kübler offers a wide range of possible outputs and voltage supplies for any application:

Output	Inverted signals	Voltage supply
RS422 (TTL compatible)	yes	5 V DC
RS422 (TTL compatible)	yes	10 ... 30 V DC or 5 ... 30 V DC
Push Pull output	no	10 ... 30 V DC or 5 ... 30 V DC
Push Pull output	yes	10 ... 30 V DC or 5 ... 30 V DC
Push Pull (7272)	yes	5 ... 30 V DC
Sine wave voltage output	yes	5 V DC
Sine wave voltage output	yes	10 ... 30 V DC

If the encoder is to be used in an environment that has a high level of electrical noise or if long cable runs are used, then the use of inverted signals is highly recommended.

Sensor outputs

With long cable runs, the inherent resistance of the cables can lead to a situation where insufficient supply voltage is available to the encoder.

Using the sensor outputs of the encoder, the voltage present can be measured and if necessary increased accordingly.

Digital outputs

The sine wave signal from the optical system is first digitised to have square wave signals available.

- Shaft turning clockwise, top view of shaft
- Inverted signals are available
- 0 pulse is linked to AND with channel A and B

To transmit the signals there are two possible outputs available. RS422 (TTL compatible) or push-pull.

When choosing the suitable output for the application the following points have to be considered:

- The corresponding unit / controller the encoder will be connected to
- The required cable length
- The sensitivity against electrical noise or other interference

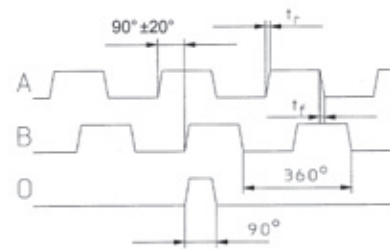

Push-pull outputs

Push-pull outputs are suitable for count interface cards, electronic counters or PLC inputs. They are available in two versions:

Push-pull:

- Push-pull with integrated wave impedance adjustment, recommended cable impedance 40 ... 150 Ω
- Recommended for long cable lengths, high pulse frequencies and output voltages to 30 V
- With or without inverted (complementary) signals

Push-pull (7272):

- Universal line driver 5 ... 30 V with low-level (max 0.5 V)
- Recommended for cable lengths up to 30 m
- With inverted signals

Output circuit and recommended input circuit push-pull without inverted signals

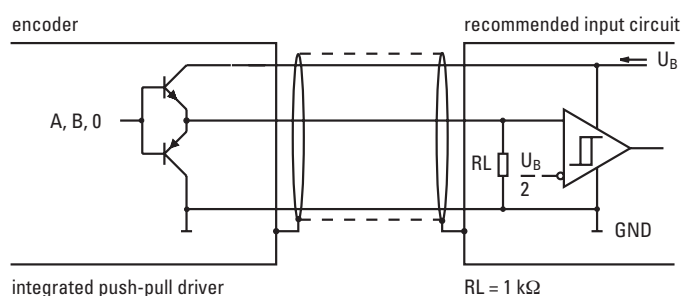

Output circuit and recommended input circuit push-pull with inverted signals

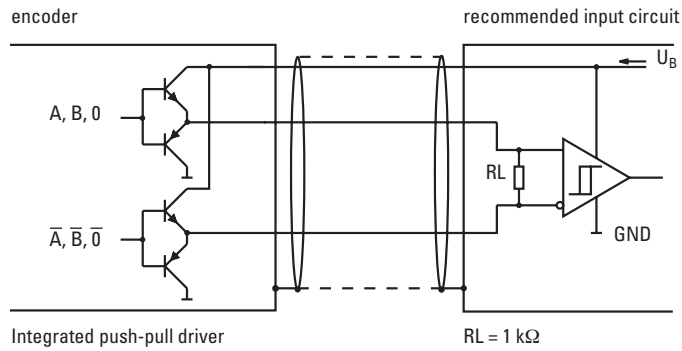

RS422 Output circuit and recommended input circuit

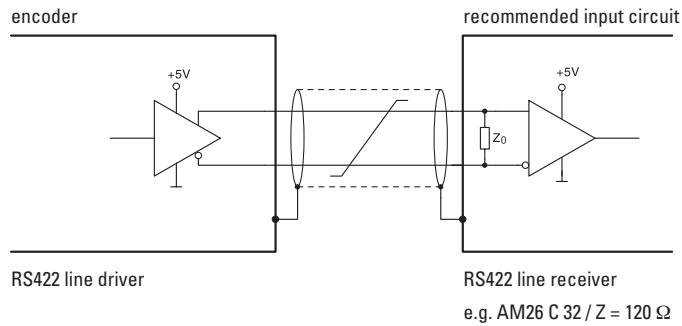

Sine wave outputs

The sine wave signals are available as voltage signals. They can be further processed in the evaluation electronics. Due to the interpolation of the two signals, which are 90° out of phase, a very high resolution can be achieved.

Further they are very suitable for digital drives with a very slow movement, e.g. for grinding machines or lifts and elevators.

- Shaft turning clockwise, top view of shaft
- 0 pulse is generated once per turn

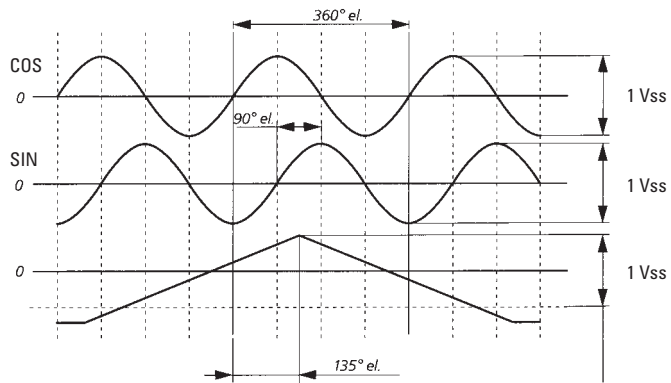

Output circuit and recommended input circuit for sine wave voltage signals

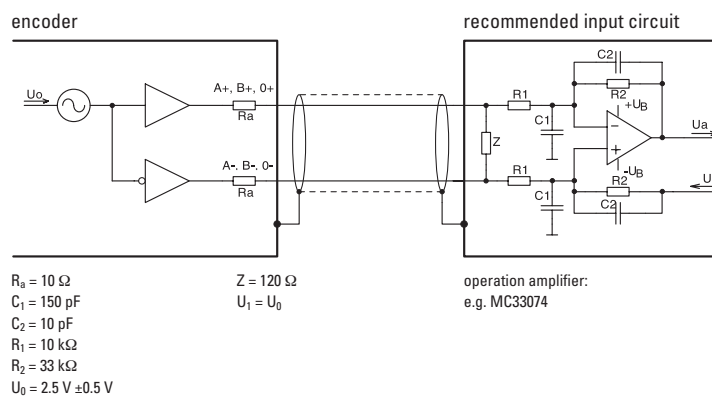

Cable lengths for incremental encoders

Depending on the output circuit and the electrical noise the following cable lengths are recommended:

Output circuit	max. cable length	Encoder connected to e.g.
Push-pull without inverted signals	100 m ¹⁾	Kübler counter/SPS
Push-pull with inverted signals	250 m ¹⁾	SPS/IPC ²⁾
Push-Pull with inverted signals (7272)	30 m	
RS422 with inverted signals	up to 1000 m (> 50 m dep. on frequency)	SPS/IPC ²⁾
Voltage sine with inverted signals	50 m	SPS/IPC ²⁾
Sine wave 1 Vss	50 m	10 ... 30 V DC

Annotations:

- Depending on the application the recommended cable length can be shorter, especially in areas with a high level of electrical noise.
- Always use shielded cables - the shield should be connected at both the encoder and controller ends!
- The core diameter of the signal cores should be > 0.14 mm²
- The core diameter of the voltage supply cores should be large enough depending on the cable length, that the voltage supply of the encoder is high enough and the signals do not go below the minimum levels!

1) Depends on frequency

2) IPC = industrial PC

Design and function

Optical Scanning

The light that is emitted by an LED is modulated by a code pattern, which is applied to a rotating disc; this is scanned by a special Kübler Opto ASIC. A unique bit pattern is assigned to each position and this is generally available as Gray Code.

The advantage, compared with incremental encoders, lies in the fact that any movement of the shaft whilst voltage is not applied is immediately detected when power is re-applied, ensuring the correct position is always available.

Advantage:

No reference runs after starting-up are necessary as with incremental systems.

Safety is increased and the time taken for reference runs is saved.

Magnetic Scanning

The magnetic field created by a rotating permanent magnet is scanned by a sensor ASIC. Each angular position has underlying field vectors, which are converted by the ASIC into an electrical signal.

Depending on the version, this output signal can be either SSI, 0...10V, 4...20mA or CANopen.

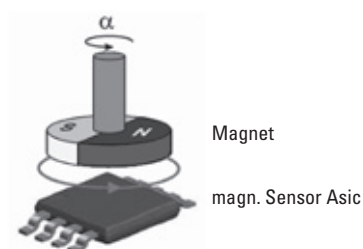

Mechanical advantages of Kübler encoders

- Sturdy bearing construction, Safety-Lock™ and Safety-Lockplus™, interlocked bearings, large bearing span and extra strong outer bearings ensure stability when subjected to vibration and a rugged ability to withstand installation errors. Machine downtime and repairs are thus eliminated.

Encoders with Safety-Lockplus™ Design are additionally equipped with a mechanically protected shaft seal.

- Ideal for use outdoors thanks to its solid die-cast housing and radial shaft seal. The Sendix

Absolute benefits from a high IP67 protection rating and a wide operating temperature range from -40 °C up to +90 °C.



Versions

Singleturn encoders

Depending on the number of divisions they generate unique positions per revolution. After one complete revolution the process re-commences at the start position.

They are suitable for angular measurement over a maximum of one turn of the shaft (=360°), for example in robotics, with cam controllers and in other controlled rotary motion.

Multiturn encoders

Up to 17 Bit unique angular positions per revolution are provided. In addition the number of revolutions is detected. Up to 4096 (12 Bit) unique revolutions can be made available on the output.

Multiturn encoders are suitable for angular measurement over more than one turn of a shaft, for example with longer traverse paths, such as high rack storage areas, cranes or machine tools.

Code types

Binary Code

The Binary Code can be processed very easily by computer systems. When using optical read-out, errors may occur, because the change from one bit to another on the different concentric tracks

(LSB, LSB+1...) is not exactly synchronized. Due to this, without any correction of the code, the position information could be wrong.

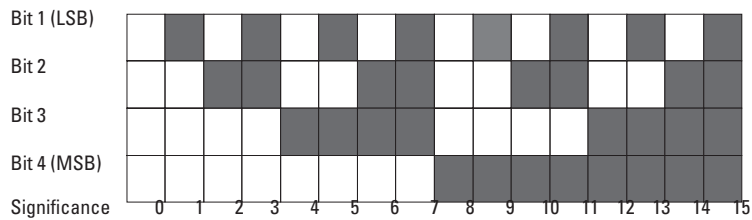

Gray Code

The Gray Code is a single-step code, which guarantees that from one position to the next only 1 bit changes.

This leads to reliable scanning of the code and consequently of the positions.

Symmetrically capped Gray Code (Gray-Excess):

If a particular section of the complete Gray Code is extracted, this results in the so-called Gray Excess Code

This permits even-numbered divisions, such as 360, 720, 1000, and 1440.

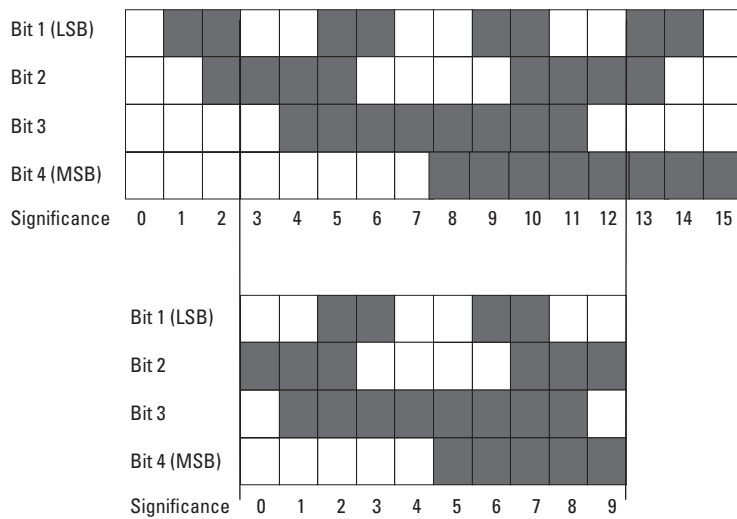

Reversion of the Gray Code

The code values increase when the shaft is turning clockwise.

The Gray code is reversible, i.e. if the most significant bit (MSB) is inverted, the code values decrease when the shaft is turning clockwise.

Encoders
Absolute Encoders
Patented Integrative Technology

Integrative Technology, developed and patented by Kübler, is a package of measures that ensures compact construction, high signal quality, high shock resistance - up to 2500 m/s², high reliability and a high level of immunity to EMC.

This is achieved using an Opto ASIC, a multilayer board and an especially shock resistant and space-saving method of mounting the sensor unit. In addition the use of a highly optimized interface ASIC ensures the integration of several hundred individual components. Components that had previously been needed to balance the system, such as balancing potentiometers, can be dispensed with.

Advantages of Integrative technology:

Singleturn shaft encoders are available with the same dimensions as their incremental counterparts. This allows for easy mechanical substitution.

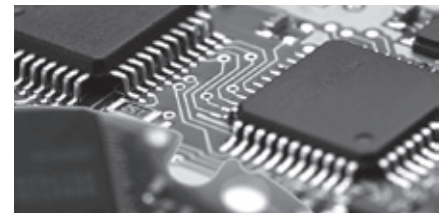
The mechanical Sendix multiturn stage with gear

- Multiturn gear with purely optical scanning technology. Completely resistant to magnetic fields.
- First stage with double bearing layer
- Special materials ensure temperature stability and long service life
- Through hollow shaft diameter up to 14 mm - up to 15 mm as blind hollow shaft
- Specially developed gear teeth allow for very high rotational speeds and eliminate wear

The patented electronic electronic Sendix multiturn stage with Intelligent Scan Technology™

Firstly all the single and multiturn functions of the encoder are integrated on an Opto ASIC and offer thus highest reliability.

With multiturn versions the optical sensor technology can achieve a resolution of up to 41 bits.

Furthermore, the new Intelligent Scan Technology ensures 100% magnetic insensitivity.

Sendix F36: The compact revolution

The absolute multiturn and singleturn variants with a size of just 36 mm are able to offer a through hollow shaft diameter of up to 10 mm.

The Sendix F36 are the first multiturn encoders with Intelligent Scan Technology™.



Recipients of the MessTec & Sensor Master 2010 Award and the Golden Mousetrap Award 2009.

Mechanical or electronic gears?

Absolute singleturn and multiturn encoders have established themselves as the standard method for measuring linear displacement or angular position.

With absolute encoders a reference trip is no longer needed after system start-up or a power-down. Multiturn encoders in particular are now being employed, where previously incremental encoders had predominated, for example with geared motors or in lifts.

Today all manner of multiturn encoders are available in a variety of designs.

As a rule the manufacturers offer either mechanical gears for 'counting turns', or swear by electronic counters with electronic data storage. They are critical of any other technology.

The fact is however: it is not a case of which is better or worse; each technology has its advantages and drawbacks.

Only the actual application can decide.

Outputs

To transfer the position data to a controller, different interfaces are available.

Synchronous Serial Interface (SSI)

Compared to the parallel interface, the SSI interface needs less components and the EMC-characteristics are much better.

In addition less lines are needed for transmission and the possible cable length is much longer.

Output circuit and recommended input circuit

5862, 5882, 9081

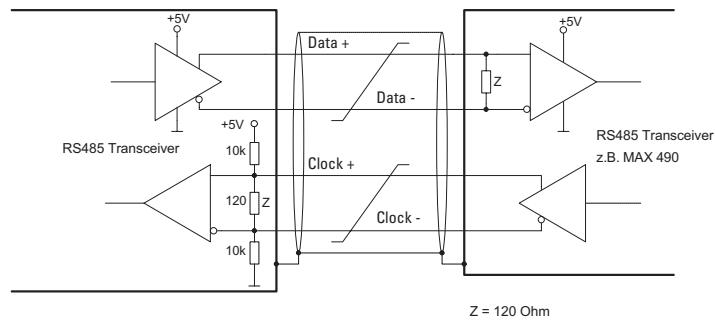

Z = 120 Ohm

Data transmission SSI

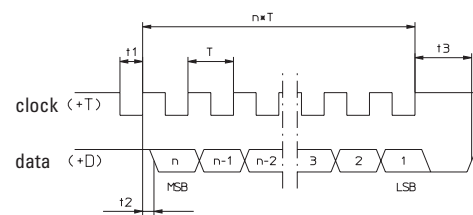

$$t_1 = T / 2$$

$$t_2 < 1 / (4 \times f_{\max})$$

$$t_3 = \text{Monoflop time (see below)}$$

$$n = \text{Resolution in bit}$$

$$1 / f_{\max} \leq T \leq 1 / f_{\min}$$

$$f_{\min} = \text{min. clock rate (see data sheet)}$$

$$f_{\max} = \text{max. clock rate (see data sheet)}$$

At rest, the clock and data lines are at a high level. With the first falling clock-pulse edge, the current encoder data are stored in the buffer ready to be sent. With the next rising clock-pulse edge, the data are transmitted bit by bit, starting with the MSB. The transfer of a complete data word requires $n+1$ rising clock-pulse edges (n =resolution in bit), e.g. 14 clock signals for a complete readout of a 13 bit encoder.

After the last positive-going clock-pulse edge the data line will remain for the duration of the monoflop time t_3 at a low level, until the encoder is ready for a new data word. The clock line must stay high for at least as long, and then can begin a new read-out sequence again with the next falling edge.

Please note!

Only for type 5850, 5870, 5862, 5882 and 9081:

The updating of the data occurs synchronously with the read-out cycle. So, the data are as up-to-date as the interval time between two read-outs.

A periodic read-out of the encoder in the application is therefore recommended, using appropriately short cycle times, so that current position values are constantly maintained. It is not possible to read out the same data word several times.

Monoflop time of the encoder: $t_3 = \text{max. } 40\mu\text{s}$

Only for the new Sendix Absolute encoders:

The updating of the data occurs immediately with the first falling edge of the clock signal. The data are thus always up-to-date. If a repeated read-out of the same data word is desired, then a new clock sequence must be started within the time interval t_3 . If the clock sequence is terminated before the necessary number of clock pulses, needed for a complete readout of the data word, has been transmitted, then after a further time interval t_3 the data line will go high again and signal that the last read-out sequence has been aborted. It will also indicate that it is ready for a new data word to be sent. Monoflop time of the encoder: $t_3 = \text{see data sheet}$.

BiSS-Interface

We offer absolute encoders with a wide variety of interfaces. Details about our BiSS interface can be found on our website at:

www.kuebler.com/service/biss_en.pdf

Parallel output

This type of transfer is very fast. All bits of a position are transferred simultaneously each via a separate line.

Output circuit and recommended input circuit

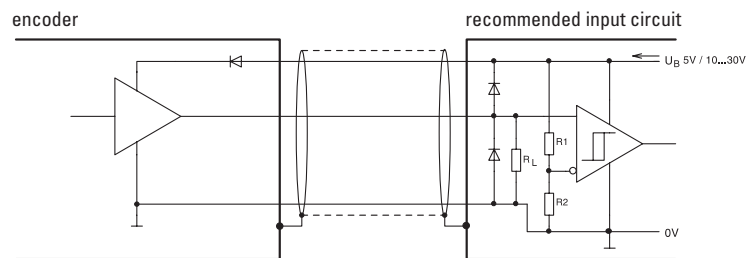

Integrated push-pull driver

Analogue output 4 ... 20 mA

Output circuit and recommended input circuit

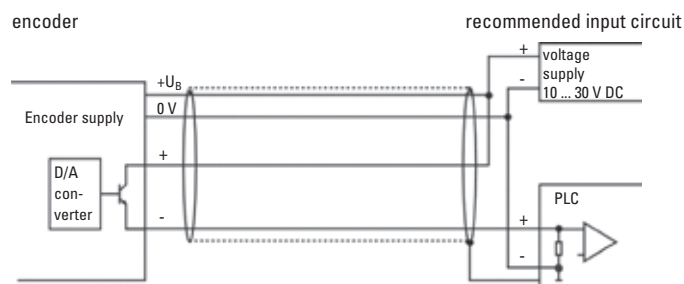

RS485 interface (half-duplex)

Output circuit and recommended input circuit

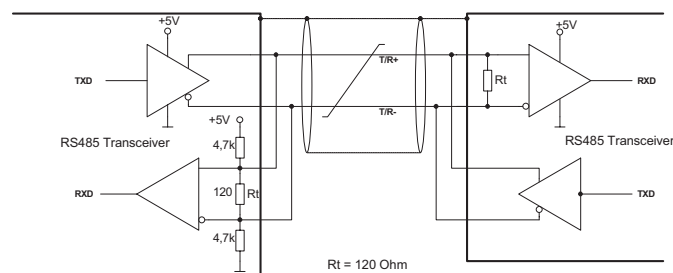

Encoders with internal termination have a fixed terminating resistor R_t built in.

This variant is designed for point-to-point transmissions between 2 devices.

With devices having external termination the user must activate the terminating resistor by placing a jumper between pins 5 and 6. This option is suitable to the construction of bus systems with several encoders.

With bus systems, the EIA-485 standard recommends terminating each end of a data link circuit with a terminating resistor.

The RS485 interface is asynchronous. In half duplex operation it is not possible to send and receive at the same time. The data transmission is controlled via ESC commands.

Bus systems

Bus systems: we offer absolute encoders with a wide variety of Fieldbus bus systems. Details about our Fieldbus bus systems can be found on our website at: www.kuebler.com/service/fieldbus.pdf



Cable lengths

Cable length: the following maximum cable lengths are recommended, depending on the output circuitry and any noise sources present:

Interface and output circuit	max. cable length	Connected to
Parallel CMOS/TTL	2 m	SPS/IPC ¹⁾
Parallel push-pull	100 m	SPS/IPC ¹⁾
SSI	up to 1000 m ²⁾	SPS/IPC ¹⁾
RS422 /RS485	1000 m	SPS/IPC ¹⁾
Analogue 4 ... 20 mA	200 m	

Annotations:

- Depending on the application the max. allowed cable length can be shorter, especially in areas with strong electrical noise.
- Always use shielded cables
- The core diameter of the signal cores should be $\geq 0.14 \text{ mm}^2$
- The core diameter of the voltage supply cores should be large enough depending on the cable length, that the voltage supply of the encoder is high enough and the signals do not go below the minimum levels! We strictly recommend the use of the cable types written down in the accessories.

1) IPC = Industrial PC

2) Depends on clock frequency:
at 100 kHz L_{max} approx. 250 m; at $f = 250 \text{ kHz}$ L_{max} approx. 50 m

Encoders Functional Safety

Incremental and absolute encoders for Functional Safety

Safety is – not least since the EU Machinery Directive 2006/42/EG – an “integral part of the construction of drives”. When choosing the right encoder for functional safety the principle applies that safety is achieved through the intelligent combination of encoder, controller and actuator.



Product overview
Basics

Sendix SSI absolute encoders, with an additional Sin/Cos incremental output, and Sin/Cos versions of incremental encoders are available with certification. But safety goes further than this: safe components are characterised by a robust reliable interface and by the ability to cope with high mechanical and electronic loads.

Safe Incremental Encoder Function

In order to achieve safe incremental information with the encoder, the controller must monitor the validity of the analogue, 90° phase-shifted sine/cosine signals with the help of the function: $\sin^2 + \cos^2 = 1$

Safe Absolute Encoder Function

In order to obtain safe information with the encoder regarding the absolute position, the controller counts the incremental pulses and compares the result with the absolute positions also provided by the encoder.

Safe mechanical connection

A 100% reliable mechanical connection is required for a safe function in the applications. Suitably sturdy fixing elements can help eliminate the risk of faults.

Compliance with Safety Standards

According to DIN EN 13849-1 and DIN EN 61800-5-2 up to SIL3/PLe/Cat.4 the following safety functions can be implemented with the encoder:

SS1:	Safe Stop 1	controlled braking, STO after time or standstill
SS2:	Safe Stop 2	controlled braking until SOS
SOS:	Safe Operating Stop	safe operating stop in position control
SLS:	Safe Limited Speed	
SLI:	Limited Increment of Position	
SLP:	Safe Limited Position	
SSR:	Safe Speed Range	
SDI:	Safe Direction	
SSM:	Safe Speed Monitoring	

Linear Measuring Technology

Magnetic measuring system

up to 90 m measuring length, up to 0.005 mm resolution

The idea:

A magnetic sensor is guided across a magnetic band without coming into contact with it. The changes in polarity on the magnetic band are counted and intermediate values are interpolated. Our engineers have fine-tuned the system to such a degree that resolutions up to 0.005 mm are possible.

The system is not affected by dust, shavings or humidity and is resistant to many liquids and to oil.

Assembly is easy - the magnetic band just has to be glued into place. There are no problems for calibration.

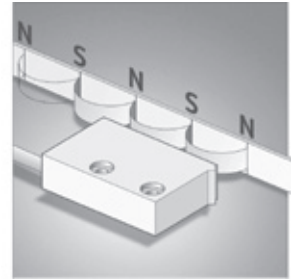

The distance between the sensor and the magnetic band can be up to 2 mm.

Repeat accuracy is very high.

Where is our LIMES system used?

The measuring system offers an economical alternative to optical systems in applications where the high accuracy of the glass rules is not absolutely necessary but where up till now no other suitable alternative has been available.

Because of its rugged construction the measuring system can now be used even in tough industrial environments.

The system is not affected by vibration nor is it damaged if subjected to high shock loads.

Our flexible magnetic band offers a further interesting area of application, due to the fact that it can be fitted round very large shafts.

The maximum length of the magnetic band is 90 m!

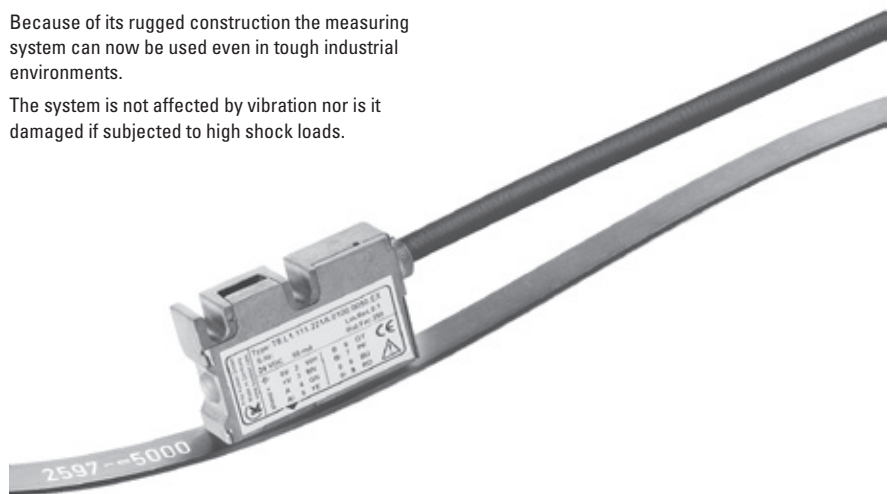

Length measuring kits

unlimited length, resolution up to 0.1 mm

We have taken our expertise from the fields of sensor and counting technology and applied this to length measuring kits.

We will supply you the measuring wheel, the encoder and the counter – **all from one source.**

Plug in and go – saves you time and effort – no need to assemble the component parts.

We supply the complete kits.



Draw wire systems

Measuring length up to 40 m,
Resolution up to 0.1 mm



The idea:

At the core of a draw wire encoder is a drum mounted on bearings, onto which a wire is wound. The winding takes place via a spring-loaded device. The number of revolutions is measured by means of an encoder. If the circumference of the drum is known, then the length can be calculated from it.

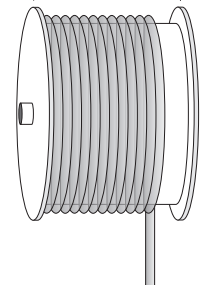

- Specially for demanding applications
- With analogue sensors (0 ... 10 V, 4 ... 20 mA, potentiometer) or encoders (incremental, absolute, fieldbus)
- Measuring lengths from 250 mm up to 40000 mm
- High travelling speed
- High acceleration
- Dynamic spring traction by means of a constant force spring, long service life
- Simple wire fixing using clip
- Quick mounting
- Diamond-polished ceramic guide
- Titanium anodised aluminium housing

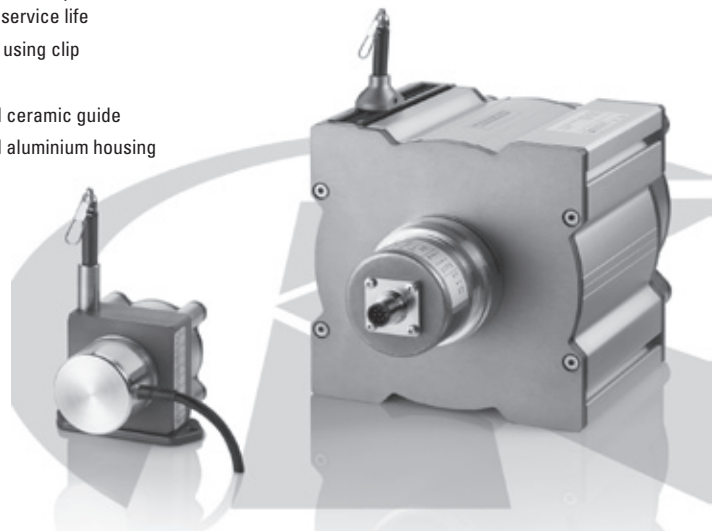

The idea behind our Connection Technology System



Connection Technology from Kübler = System Safety!

All the products in the Connection Technology section have been tested and approved with the relevant compatible Kübler sensors.

They ensure the full functionality and high signal quality of our sensors.

Your benefit:

- Elimination of connection errors
– no laborious fault finding
- Optimal shielding
– avoids EMC problems
- Shorter installation times
– saves time, cuts costs
- No time-consuming search for the right connector or cable
– saves time, eliminates errors

