

		Page
Product overview		6
<hr/>		
Technical basics	Slip rings	10
	Optical fibre signal transmission modules	15
	Cables and connectors	16

You will find comprehensive information about the basic technical knowledge relating to our products on our homepage, at the address www.kuebler.com/basics

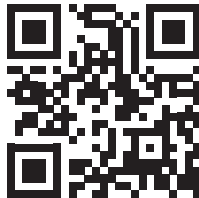

Slip rings

General information / Mounting

Description

Slip rings are basically used for transmitting electrical current, signals or data, pneumatics and hydraulics from a stationary to a rotary platform.

Kübler slip rings feature a particularly rugged compact design, long maintenance cycles and a long service life.

In slip rings, the electrical transmission between the stator and rotor units takes place via sliding contacts and is extremely reliable.

The SR085 family has a modular construction and offers highest flexibility for a wide variety of applications.

Slip ring mounting

Hollow shaft mounting

- Slide the slip ring on the hollow shaft
- Tighten the setscrews and secure them with screw stop varnish
- Secure the slip ring against rotation with the torque stop

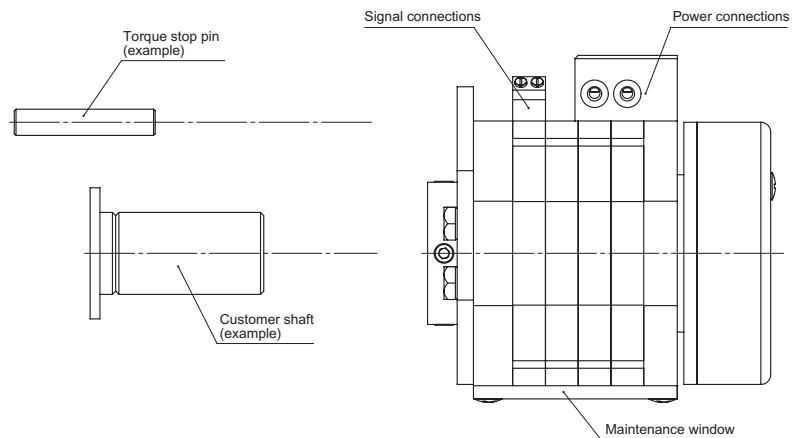

Flange mounting

- Connect the electrical and pneumatic transmission
- Fasten the flange with the screws and secure the screws with appropriate means, e.g. spring washers, screw stop plates
- Secure the slip ring against rotation with the torque stop

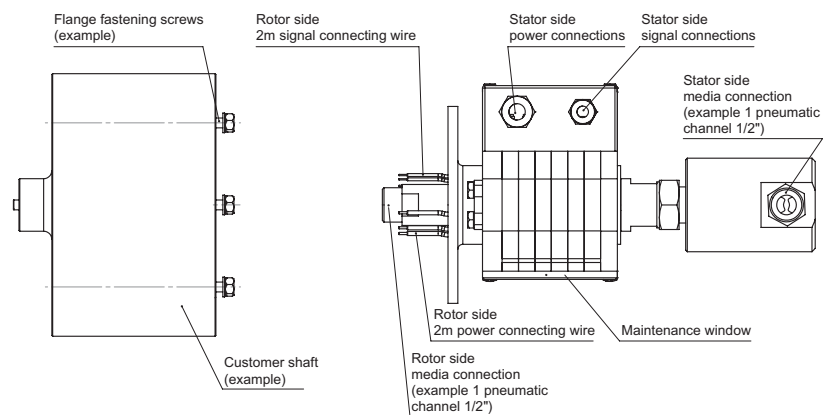

Slip rings Mounting

Mounting position

The slip rings of the SR085 and SR060 series can be configured for the following electrical transmissions:

- Only signal transmission
- Only power current transmission
- Mixed transmission of signals and power

In the latter case, for a vertical installation, care must be taken so that the signal rings are always located on top. This reduces the possible risk of contaminating the signal contacts.

The slip rings of the SR085 series may be installed standing, horizontally and suspended.

A distinction is thus made among the installation positions in order to minimize the contamination of the signal channels.

The slip rings of the SR060 series are designed only for horizontal or suspended installation.

The mounting position is to be defined in the order code as follows:

SR085-XX-XX-XX-X1XXX-VXXX

in case of standing and horizontal installation (flange at the bottom)

SR085-XX-XX-XX-X2XXX-VXXX

in case of suspended and horizontal installation (flange on top)

SR085-XX-XX-XX-X0XXX-VXXX

in case of only load or only signal transmission

Mounting position standing

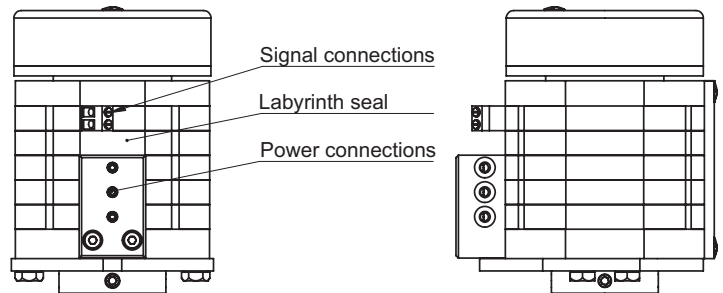

Ex. of mounting shaft (customer side)

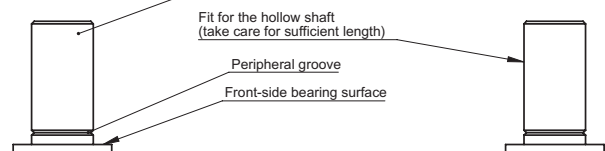

Mounting position suspended

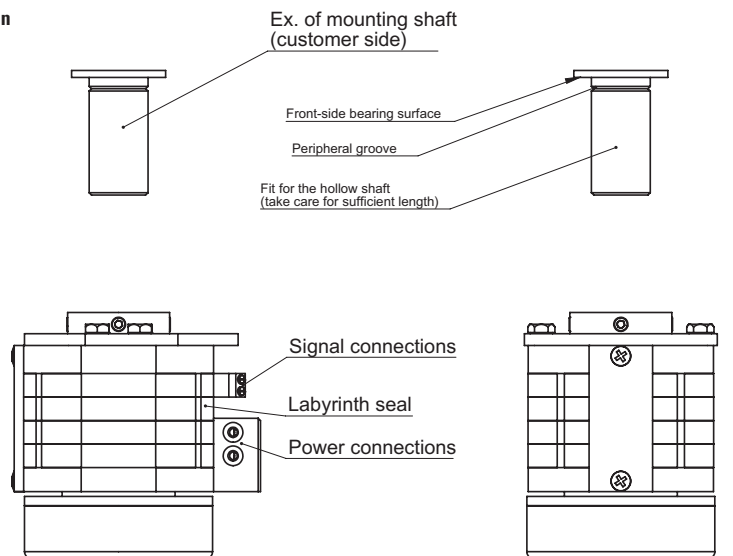

Ex. of mounting shaft (customer side)

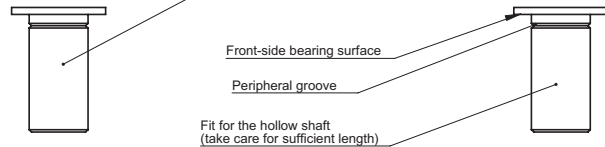

Slip rings Contactmaterials and characteristics

For load transmission

Copper alloy

Use: Standard contacts for power channels

Characteristics: Suitable for high currents, very low voltage drop, very low friction coefficient, and thus long service life



Stator ring with copper alloy contacts

Bronze

Use: Standard slip ring for power channels

Characteristics: Good contact properties, long service life



Bronze slip rings with insulator

For signal / data transmission

Silver alloy

Use: Standard contact for signal/data channels

Characteristics: Safe transmission of data and signals, especially for very low currents and voltages, very low contact resistance, easy maintenance, no contact oil required, long service life, longer maintenance cycles



Stator ring with silver alloy contacts

Precious metal alloy

Use: As a standard slip ring for signal channels, paired with silver alloy contacts

Characteristics: Safe transmission of data and signals, especially for very low currents and voltages, very low contact resistance. Suitable for intermittent operation (long standstill periods)



Slip rings out of special precious metal alloy with insulator

Slip rings Maintenance

Maintenance

Regular and appropriate maintenance is determining for the safety and service life of the slip ring.

Unless otherwise specified in the technical data sheet, the following maintenance intervals apply:

- 1st interval after max. 50 million revolutions or after 1 year
- Every further maintenance interval max. 100 million revolutions or at the minimum once per year



Product Overview
Basics

Maintenance plan

Depending on the rotational speed and on the operating mode, the specified maintenance intervals are reached more or less quickly. In case of continuous operation and corresponding rotational speeds, maintenance will be required, depending on the contact material of the signal/data channels, after the following number of months of operation:

Signal/data channels, contact material silver alloy / precious metal

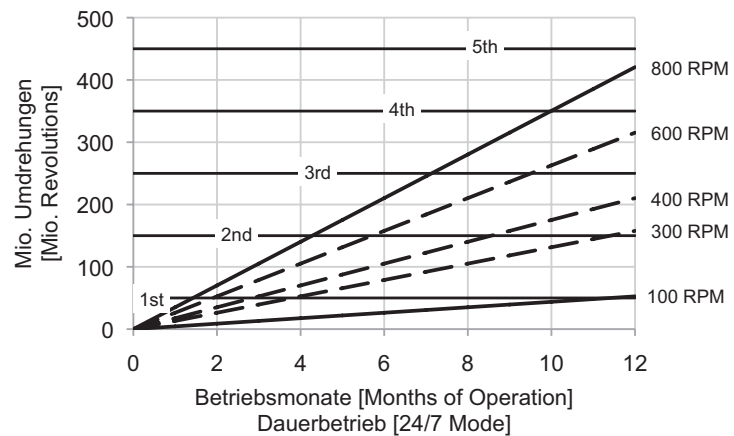

Slip rings

Maintenance

Position of the maintenance window

Slip ring with maintenance window at the bottom
(slip ring for power current up to 16 A)

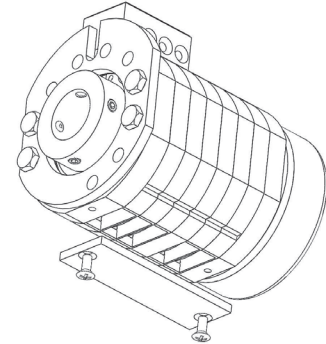

Slip ring with maintenance window on the side
(slip ring for power current over 16 A)

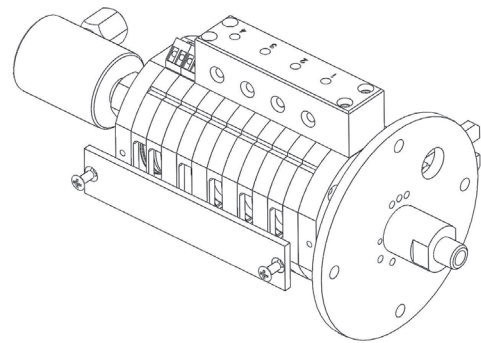

Note:

The accurate description of the maintenance work can be found in the respective maintenance instructions.

Rotational speeds

The maximum rotational speed depends on the mounting position and on the number of channels eg. housing rings (see fig.).

For higher rotational speeds, please contact the manufacturer.

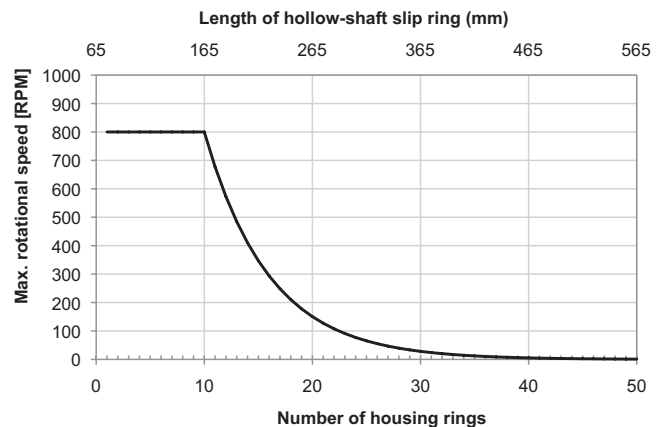

Slip rings are to be mounted by the customer so as to prevent them from oscillating and to ensure optimal rotation. The setscrews must be tightened evenly.

Unless otherwise specified, the shaft receiving the slip ring should have a h7 fit.

Whenever possible, always tighten the opposite screws consecutively and evenly. In addition, at least 1/3 of the whole slip ring length should be in contact with the shaft.

Safety-Trans™-Design

Two-chamber system for simultaneous load and signal transmission. The power and the signal area are separated by a special labyrinth seal. This allows minimizing a possible contamination of the signal contacts.

Optical fibre signal transmission	General information	
<p>Description</p>	<p>The system is made up of an optical fibre transmitter and an optical fibre receiver.</p> <p>The optical fibre transmitter converts the electrical signals of an encoder into optical fibre signals. A simple glass fibre allows reliable transmission up to distances of 1500 m.</p> <p>The receiver module converts the optical signals back into electrical signals.</p> <p>The modules are available in various level and power supply voltage variants.</p>	<p>Main advantages of an optical fibre transmission:</p> <ul style="list-style-type: none"> • Insensitivity to electromagnetic interferences and to leakage effects between lines routed parallel • Significantly higher transmission speeds • The optical fibre cable can be routed through explosive atmospheres • Cost and weight savings thanks to reduced cabling work, especially for important cable lengths
<p>Mounting of optical fibre modules</p>	<p>The optical fibre modules can be mounted directly on a TS35 DIN rail (top-hat rail) according to EN 50022.</p> <p>The installation width for every module is only 22.5 mm.</p>	
<p>Laying and connection of glass fibre cables</p>	<p>Laying the cable is generally easy.</p> <p>Care must nevertheless be taken to make sure that the bending radius does not become smaller than 30 mm for static laying and 60 mm for dynamic laying.</p> <p>When connecting the cable, make sure that the bayonet catch is locked and remove the dust protection caps only just before connecting the cable.</p>	
<p>Glass fibre cables</p>	<p>The modules can be connected together using 50/125 µm or 62.5/125 µm multimode glass fibre cables with ST/PC type connectors with bayonet catch. Single-mode Simplex patch cables are not suitable.</p> <p>Kübler offers finished confectioned patch cables adapted to the optical fibre modules as accessories.</p> <p>They ensure the full functionality and high signal quality of our sensors.</p>	

Connection technology

Introduction / Cables and connectors

Introduction

All products of chapter Connection technology have been tested and released in relation with the corresponding compatible Kübler sensors.

They ensure the full functionality and high signal quality of our sensors - this guarantee is supported by our competent customer service.

Your advantage:

- Prevents from misconnections
 - No time-consuming search for errors
- Optimal shielding
 - Prevents from EMC problems
- Shorter mounting times
 - Time- and thus cost-savings
- No time-consuming search for the suitable connector or cable
 - Time-savings and error prevention

Material information - Cables

PVC

- Suitable for average mechanical stresses in the area of packaging machines and assembly and production lines
- Good resistance against acids and alkalis and thus predestined for use in the food and beverage industry
- Limited friction resistance and partial resistance to oils and chemicals

PUR

- Flexible, PVC, silicone and halogen-free control cable with PUR cable jacket and polypropylene wire insulation
- The cable is oil-resistant and non-flammable according to VDE 0472, and it is resistant to chemicals, hydrolysis and microbes
- Temperature resistance from -30°C to +90°C
- Use is possible in trailing cable carriers with a bending radius equal at least to 10 x D
- Thanks to its resistance to welding sparks, this cable is very well adapted for flexible use in the area of robotics, machine tools and metal cutting production

Material information - Connectors

Two material groups are used for the connectors described in the catalogue:

Metals for contacts and housings

- Contacts:
Metal, CuZn, gilded
- Connecting nut /compression screw:
Metal, CuZn, nickel-plated

Plastics for insulator and housing

- Contact carrier:
Plastic, TPU, black
- Body:
Plastic, TPU, black
- Seal:
Plastic, fluorine rubber (FKM/FPM) FPM/FKM or nitrile-butadiene rubber (NBR)

Connection technology

Cables and connectors

Coding of the M12 x 1 connectors

The connectors are coded to guarantee protection against polarity reversal. This coding is achieved by means of a peg or a notch in the contact carrier.

Kübler connectors make a distinction between A, B or D coding.

A-coding

Female connector with coupling nut: Coding notch
 Male connector with external thread: Coding peg
 Use: CANopen and 8-pin connector

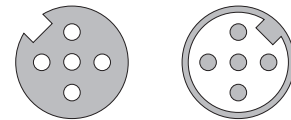

B-coding

Female connector with coupling nut: Coding peg
 Male connector with external thread: Coding notch
 Use: Profibus

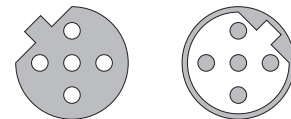

D-coding

Female connector with coupling nut: Coding peg and Coding notch
 Male connector with external thread: Coding peg and Coding notch
 Use: Profinet and EtherCAT

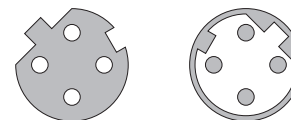

Shielding

With round connectors, care must be taken to connect carefully the shielding braid of the cable to the shield connection of the connector.

An all-round contact (360°) is optimal. Good (in practice often sufficient) shielding values are also reached by connecting the shielding braid firmly to the electrically conductive housing. Connectors purely out of plastic, without metal sleeve, providing no contact for the shielding braid, are not sufficient.

Furthermore, a proper contact with the mating connector is also important, as well as a good contact of the mating connector with the chassis of the equipment.



"Allround" shielding with Kübler cordsets

Counting direction cw/ccw

The counting direction of the connectors is indicated by cw for a clockwise arrangement and ccw for a counter-clockwise arrangement. The connector is always viewed from the mating side.

Top view of mating side



Counting direction cw (e.g. female connector)

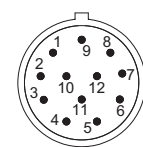

Counting direction ccw (e.g. male connector)